

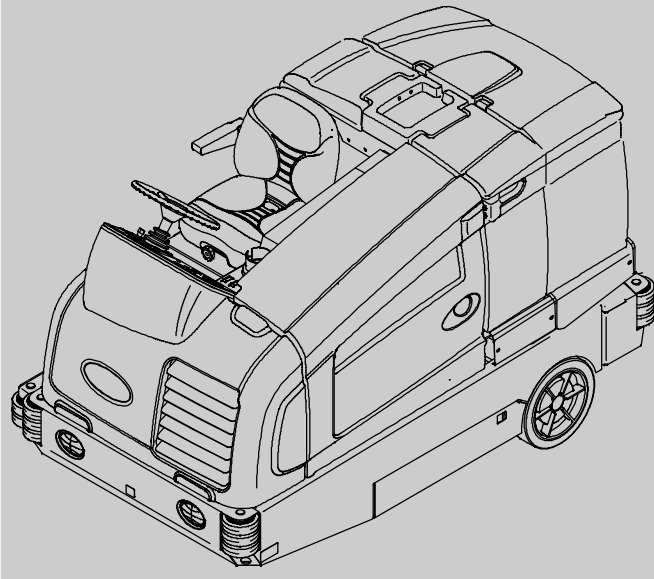

# T20

(Gas / LPG)



## Rider Scrubber Operator Manual

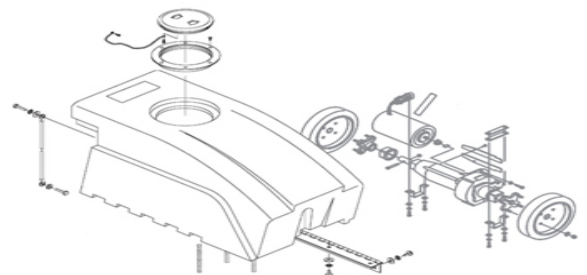

[FLOOREQUIPMENTPARTS.COM](http://FLOOREQUIPMENTPARTS.COM)



**The Safe Scrubbing Alternative®**

**Hygenic® Fully Cleanable Tanks**  
**FloorSmart™ Integrated Cleaning System**  
**ES® Extended Scrub System**

**North America / International**

[www.tennantco.com](http://www.tennantco.com)

**331470**  
**Rev. 05 (5-2009)**





This manual is furnished with each new model. It provides necessary operation and maintenance instructions.

**Read this manual completely and understand the machine before operating or servicing it.**

This machine will provide excellent service. However, the best results will be obtained at minimum costs if:

- The machine is operated with reasonable care.
- The machine is maintained regularly - per the machine maintenance instructions provided.
- The machine is maintained with manufacturer supplied or equivalent parts.

	<b>PROTECT THE ENVIRONMENT</b> Please dispose of packaging materials, old machine components such as batteries, hazardous fluids including antifreeze and oil, in an environmentally safe way according to local waste disposal regulations.
	Always remember to recycle.

<b>MACHINE DATA</b>	
Please fill out at time of installation for future reference.	
Model No. -	_____
Serial No. -	_____
Machine Options -	_____
Sales Rep. -	_____
Sales Rep. phone no. -	_____
Customer Number -	_____
Installation Date -	_____

**Tennant Company**  
PO Box 1452  
Minneapolis, MN 55440  
Phone: (800) 553-8033 or (763) 513-2850  
[www.tennantco.com](http://www.tennantco.com)



**CALIFORNIA PROPOSITION 65 WARNING:**

**Engine exhaust from this product contains chemicals known to the State of California to cause cancer, birth defects, or other reproductive harm.**

Thermo-Sentry, Touch-N-Go, 1-STEP, Clean-Wedge, Variable Drain Valve, EasyOpen, Grip-n-Go, MaxPro, Dura-Track, SmartRelease, InstantAccess, Duramer, FaST-PAK, ErgoSpace and Lower Total Cost of Ownership are US registered and unregistered trademarks of Tennant Company.

Specifications and parts are subject to change without notice.

Original Instructions, copyright © 2006 - 2009 TENNANT Company, Printed in U.S.A.

**CONTENTS**

	Page		Page
SAFETY PRECAUTIONS .....	3	SCRUBBING .....	25
OPERATION .....	7	DOUBLE SCRUBBING .....	26
MACHINE COMPONENTS .....	7	WATER PICKUP MODE	
CONTROLS AND INSTRUMENTS .....	8	(NO SCRUBBING) .....	27
TOUCH PANEL .....	9	EMPTYING AND CLEANING THE	
SYMBOL DEFINITIONS .....	10	DEBRIS TRAY - CYLINDRICAL	
OPERATION OF CONTROLS .....	11	SCRUB HEADS ONLY .....	28
CHARGING SYSTEM INDICATOR ...	11	DRAINING AND CLEANING THE	
ENGINE OIL PRESSURE INDICATOR	11	RECOVERY TANK .....	30
CHECK ENGINE INDICATOR .....	11	DRAINING THE RECOVERY TANK	
PARKING BRAKE INDICATOR		WITH THE DRAIN HOSE .....	30
(OPTION) .....	11	DRAINING THE RECOVERY TANK	
SETTING THE ENGINE SPEED .....	12	WITH THE DRAIN PLUG .....	31
SIDE BRUSH (OPTION) .....	12	DRAINING AND CLEANING THE	
FUEL INDICATOR .....	12	SOLUTION TANK .....	33
GASOLINE MACHINES .....	12	FAULT INDICATOR(S) .....	35
LPG MACHINES .....	12	CONDITIONS / WARNINGS .....	36
HOUR METER .....	13	OPTIONS .....	37
SUPERVISOR CONTROL BUTTONS .	13	SPRAY NOZZLE (OPTION) .....	37
OPERATING LIGHTS .....	13	VACUUM WAND (OPTION) .....	38
HAZARD LIGHT (OPTION) .....	13	POWER WAND (OPTION) .....	39
OPERATOR SEAT .....	14	MACHINE TROUBLESHOOTING .....	41
SEAT BELTS .....	14	MAINTENANCE .....	43
STEERING COLUMN TILT KNOB ....	14	MAINTENANCE CHART .....	44
BRAKE PEDAL .....	15	LUBRICATION .....	46
PARKING BRAKE PEDAL .....	15	ENGINE OIL .....	46
DIRECTIONAL PEDAL .....	15	SQUEEGEE CASTER BEARINGS ...	46
SQUEEGEE PROTECTORS (OPTION)	15	FRONT WHEEL SUPPORT BEARING	46
HOW THE MACHINE WORKS .....	16	STEERING CYLINDER BEARING ....	46
BRUSH AND PAD INFORMATION .....	16	TORQUE TUBES-CYLINDRICAL	
WHILE OPERATING THE MACHINE ....	17	BRUSHES .....	47
PRE-OPERATION CHECKLIST .....	18	TORQUE TUBES-DISK BRUSHES ...	47
CHANGING THE LPG TANK .....	19	PIVOT SHAFT-DISK BRUSHES ....	47
STARTING THE MACHINE .....	20	HYDRAULICS .....	48
TURNING OFF THE MACHINE .....	20	HYDRAULIC FLUID .....	48
FILLING THE SOLUTION TANK .....	21	HYDRAULIC HOSES .....	49
FOAM SCRUBBING (FaST MODE) ...	21	ENGINE .....	49
CONVENTIONAL SCRUBBING MODE	21	COOLING SYSTEM .....	49
ES (EXTENDED SCRUB) MODE		AIR FILTER .....	50
WITH AUTO-FILL .....	22	FUEL FILTER (LPG) .....	51
ES (EXTENDED SCRUB) MODE -		ELECTRONIC PRESSURE	
MANUALLY FILLING TANK .....	22	REGULATOR (LPG)	
SETTING SCRUB MODES .....	23	(For machines serial number	
SETTING FaST MODE .....	23	001500 and above) .....	51
SETTING ES (EXTENDED SCRUB)		FUEL FILTER (Gasoline) .....	51
MODE .....	23	ENGINE BELT .....	52
SETTING BRUSH PRESSURE .....	23	SPARK PLUGS .....	52
SETTING SOLUTION FLOW .....	24	TIMING BELT .....	52
CONVENTIONAL AND FaST		BATTERY .....	52
SOLUTION FLOW .....	24	FUSES AND RELAYS .....	53
ES (EXTENDED SCRUB)		RELAY PANEL FUSES AND RELAYS .	53
SOLUTION FLOW .....	24	ENGINE HARNESS FUSES AND	
		RELAYS .....	54

# CONTENTS

	Page		Page
SCRUB BRUSHES AND PADS .....	54	SKIRTS AND SEALS .....	69
DISK BRUSHES .....	54	SCRUB HEAD SKIRT .....	69
REPLACING DISK BRUSHES OR		RECOVERY TANK SEAL .....	69
PAD DRIVER .....	54	SOLUTION TANK SEALS .....	69
REPLACING DISK PADS .....	55	BRAKES AND TIRES .....	70
CHECKING THE DISK SCRUB		BRAKES .....	70
HEAD STOP BUMPERS .....	56	PARKING BRAKE .....	70
CYLINDRICAL BRUSHES .....	56	TIRES .....	70
REPLACING OR ROTATING		FRONT WHEEL .....	70
CYLINDRICAL BRUSHES ....	56	PROPELLING MOTOR .....	70
CHECKING CYLINDRICAL		PUSHING, TOWING, AND	
BRUSH PATTERN .....	58	TRANSPORTING THE MACHINE ....	71
ADJUSTING THE CYLINDRICAL		PUSHING OR TOWING	
BRUSH TAPER .....	59	THE MACHINE .....	71
ADJUSTING THE CYLINDRICAL		TRANSPORTING THE MACHINE ....	71
BRUSH WIDTH .....	59	MACHINE JACKING .....	73
SIDE BRUSH (OPTION) .....	60	STORAGE INFORMATION .....	73
REPLACING THE SIDE BRUSH ....	60	FREEZE PROTECTION .....	73
FaST SYSTEM .....	61	SPECIFICATIONS .....	74
REPLACING THE FaST-PAK		GENERAL MACHINE DIMENSIONS/	
CARTON .....	61	CAPACITIES .....	74
CLEANING THE FaST SUPPLY		GENERAL MACHINE PERFORMANCE ..	74
HOSE CONNECTOR .....	62	HYDRAULIC SYSTEM .....	74
CLEANING THE FaST SYSTEM		STEERING .....	74
FILTER SCREEN .....	62	POWER TYPE .....	75
CLEANING THE FaST SYSTEM		TIRES .....	75
AIR PUMP FILTER		FaST SYSTEM .....	76
(S/N 000000 - 001742) .....	62	MACHINE DIMENSIONS .....	77
REPLACING THE FaST SYSTEM		INDEX .....	79
FILTERS (S/N 001743-        ) ....	62		
SQUEEGEE BLADES .....	63		
REPLACING (OR ROTATING) THE			
REAR SQUEEGEE BLADES .....	63		
REPLACING OR ROTATING THE			
SIDE SQUEEGEE BLADES .....	65		
REPLACING THE SIDE BRUSH			
SQUEEGEE BLADE (OPTION) ....	66		
LEVELING THE REAR SQUEEGEE ..	67		
ADJUSTING THE REAR SQUEEGEE			
BLADE DEFLECTION .....	68		

## SAFETY PRECAUTIONS

The following precautions are used throughout this manual as indicated in their description:

 **WARNING: To warn of hazards or unsafe practices that could result in severe personal injury or death.**

 **CAUTION: To warn of unsafe practices that could result in minor or moderate personal injury.**

**FOR SAFETY: To identify actions that must be followed for safe operation of equipment.**

Do not use the machine other than described in this Operator Manual. The machine is not designed for use on public roads.

The following information signals potentially dangerous conditions to the operator or equipment:

 **WARNING: Flammable materials can cause an explosion or fire. Do not use flammable materials in tank.**

 **WARNING: Flammable materials or reactive metals can cause an explosion or fire. Do not pickup.**

 **WARNING: Moving belt and fan. Keep away.**

 **WARNING: Engine emits toxic gases. Serious injury or death can result. Provide adequate ventilation.**

 **WARNING: Burn hazard. Hot surface. Do NOT touch.**

 **CAUTION: LPG engine will run for a few seconds after key is turned off. Apply parking brake before leaving machine.**

**CALIFORNIA PROPOSITION 65**

**WARNING: Engine exhaust from this product contains chemicals known to the State of California to cause cancer, birth defects, or other reproductive harm.**

**FOR SAFETY:**

1. **Do not operate machine:**
  - Unless trained and authorized.
  - Unless operator manual is read and understood.
  - If it is not in proper operating condition.
  - In flammable or explosive areas.
  - In areas with possible falling objects unless equipped with overhead guard.
2. **Before starting machine:**
  - Check for fuel, oil, and liquid leaks.
  - Keep sparks and open flame away from refueling area.
  - Make sure all safety devices are in place and operate properly.
  - Check brakes and steering for proper operation.
3. **When starting machine:**
  - Keep foot on brake and directional pedal in neutral.
4. **When using machine:**
  - Do not pick up burning or smoking debris, such as cigarettes, matches, or hot ashes.
  - Use brakes to stop machine.
  - Go slow on inclines and slippery surfaces.
  - Use care when reversing machine.
  - Do not carry passengers on machine.
  - Always follow safety and traffic rules.
  - Report machine damage or faulty operation immediately.
  - Follow mixing and handling instructions on chemical containers.

## **SAFETY PRECAUTIONS**

---

5. **Before leaving or servicing machine:**
  - Stop on level surface.
  - Set parking brake.
  - Turn off machine and remove key.
  
6. **When servicing machine:**
  - Avoid moving parts. Do not wear loose jackets, shirts, or sleeves.
  - Block machine tires before jacking machine up.
  - Jack machine up at designated locations only. Support machine with jack stands.
  - Use hoist or jack that will support the weight of the machine.
  - Wear eye and ear protection when using pressurized air or water.
  - Disconnect battery connections before working on machine.
  - Avoid contact with battery acid.
  - Avoid contact with hot engine coolant.
  - Do not remove cap from radiator when engine is hot.
  - Allow engine to cool.
  - Keep flames and sparks away from fuel system service area. Keep area well ventilated.
  - Use cardboard to locate leaking hydraulic fluid under pressure.
  - Use Tennant supplied or approved replacement parts.
  
7. **When loading/unloading machine onto/off truck or trailer:**
  - Turn off machine.
  - Use truck or trailer that will support the weight of the machine.
  - Use winch. Do not drive the machine onto/off the truck or trailer unless the load height is 380 mm (15 in) or less from the ground.
  - Set parking brake after machine is loaded.
  - Block machine tires.
  - Tie machine down to truck or trailer.

The following safety labels are mounted on the machine in the locations indicated. If these or any labels become damaged or illegible, install a new label in its place.

**FLAMMABLE SPILLS LABEL - Located on the side of the operator compartment.**



**FOR SAFETY LABEL - Located on the side of the operator compartment.**



**EMISSIONS LABEL - Located on the side of the operator compartment.**

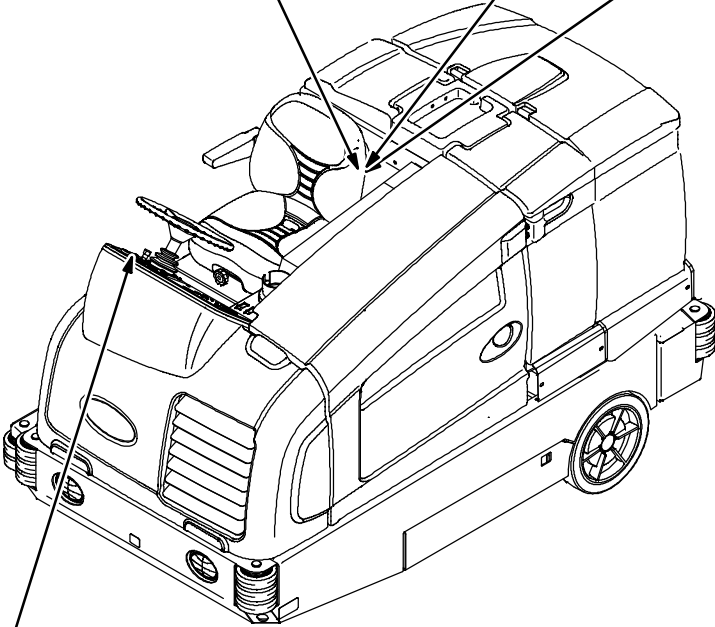

**LPG ENGINE LABEL - Located next to the ignition switch on the instrument panel. (LPG machines only)**

# SAFETY PRECAUTIONS

**FAN AND BELT LABEL -**  
 Located on engine compartment panel.



**FLAMMABLE MATERIALS LABEL -** Located next to the solution tank covers and on the detergent tank.

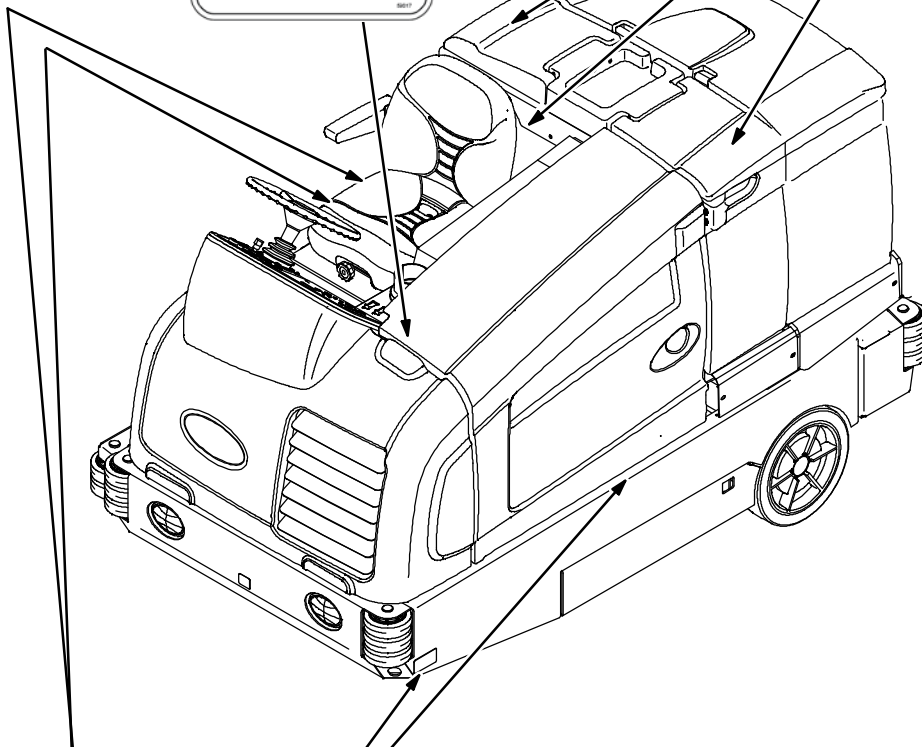

**HOT SURFACE LABEL -** Located on the side of the bumper, on the exhaust shield, on the hydraulic reservoir, and on the scrub head (disk head machines only).



## OPERATION

## MACHINE COMPONENTS



- A. Overhead guard (option)
- B. Instrument panel
- C. Front shroud
- D. Headlights
- E. Side brush (option)
- F. Side squeegee
- G. Scrub head access door
- H. Debris tray carriage release lever
- I. Fuel tank
- J. Seat shroud
- K. FaST carton or ES detergent tank compartment (option)

- L. Solution tank cover
- M. Operator seat
- N. Spray wand - nozzle behind seat (option)
- O. Flashing light (option)
- P. Audible backup alarm (option)
- Q. Recovery tank drain hose
- R. Recovery tank cover
- S. Solution tank drain hose
- T. Debris tray carriage
- U. Taillights
- V. Rear squeegee
- W. Engine cover

# OPERATION

## CONTROLS AND INSTRUMENTS

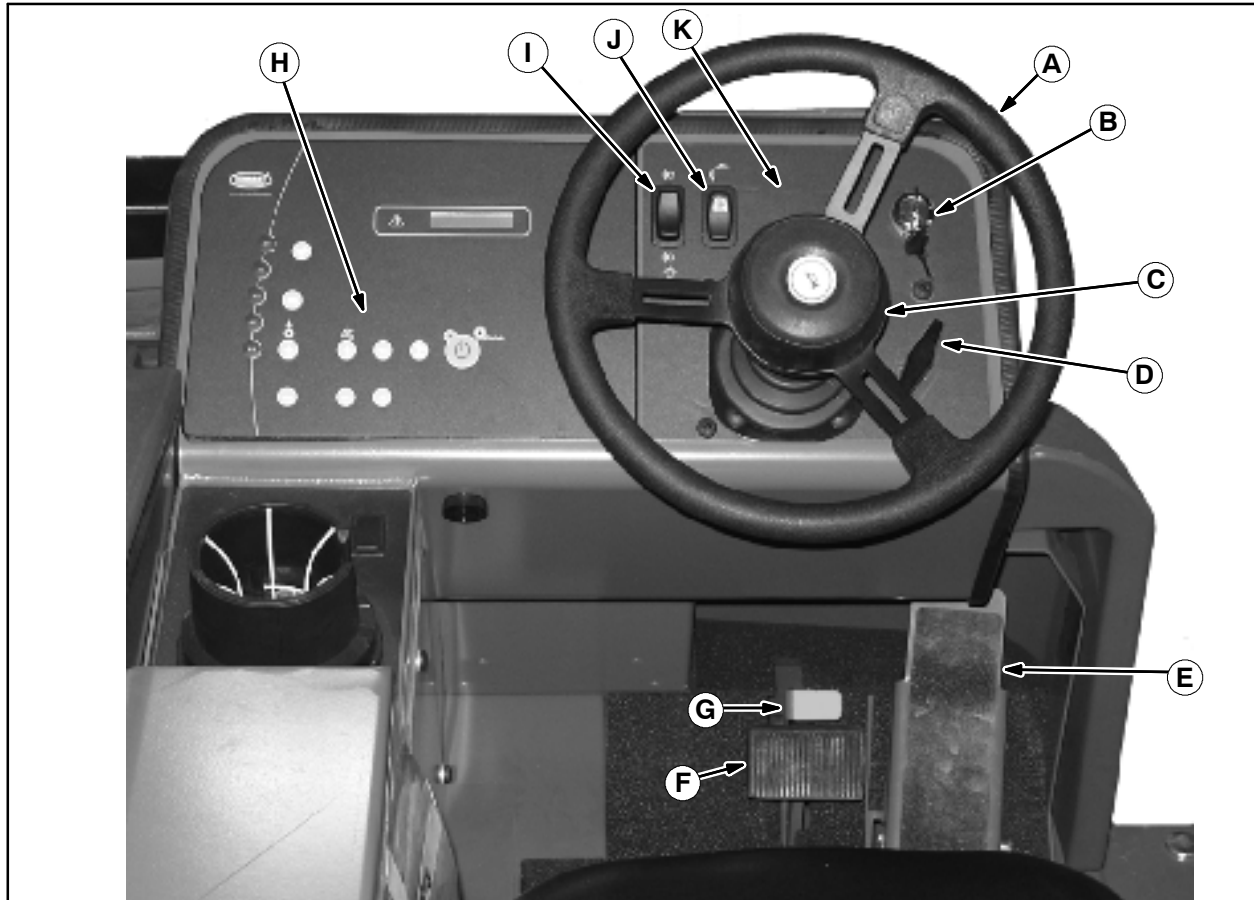

- A. Steering wheel
- B. Ignition switch
- C. Horn button
- D. Steering column tilt knob
- E. Directional pedal
- F. Brake pedal
- G. Parking brake pedal
- H. Touch panel
- I. Operating / Hazard Lights switch
- J. Spray nozzle switch (option)
- K. Engine indicator lights

## TOUCH PANEL

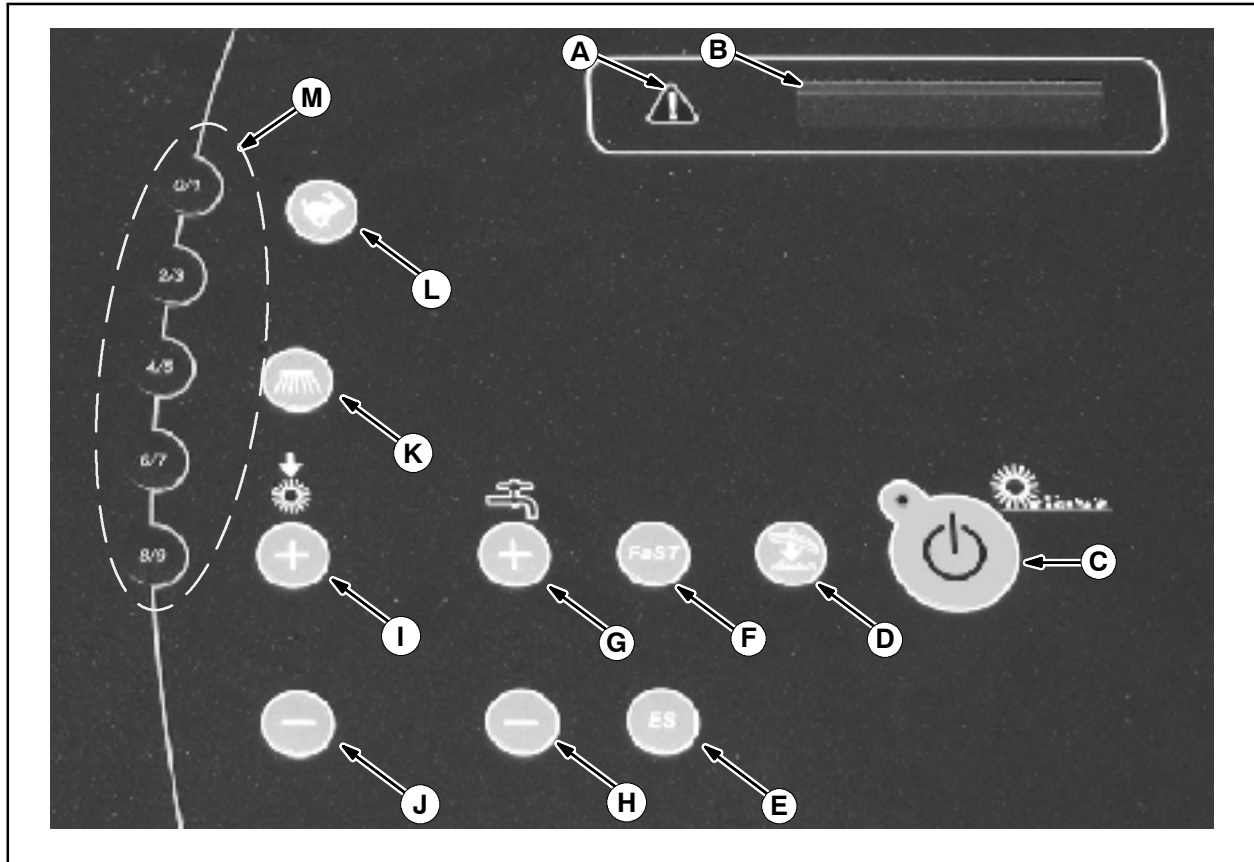

- A. Fault indicator light
- B. Hour meter / fuel indicator / fault code indicator
- C. 1-STEP scrub button
- D. Scrub vacuum fan / squeegee button
- E. ES (Extended Scrub) button (option)
- F. FaST button (option)
- G. Solution increase button (+)
- H. Solution decrease button (-)
- I. Brush pressure increase button (+)
- J. Brush pressure decrease button (-)
- K. Side brush button (option)
- L. Engine speed button
- M. Supervisor control buttons

# OPERATION

## SYMBOL DEFINITIONS

These symbols are used on the machine to identify controls, displays, and features.



Hazard light



Operating lights



Spray nozzle



Fault indicator



Scrub vac fan/squeegee



1-STEP scrub



ES (extended scrub)



FaST (foam scrubbing)



Engine speed



Side brush



Unleaded fuel only



Main brush pressure



Solution flow



Increase



Decrease



Charging system



Engine oil pressure (000000-001997)



Engine oil pressure (001998- )



Check engine (000000-001997)



Horn



Jack point



Parking Brake (001998- )

**OPERATION OF CONTROLS**

**CHARGING SYSTEM INDICATOR**

The *Charging system indicator* comes on when the alternator is not operating within the normal range. If this indicator comes on, stop the machine immediately and correct the problem.

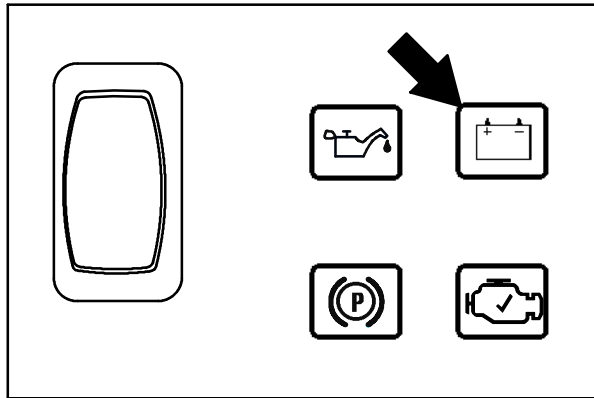

**ENGINE OIL PRESSURE INDICATOR**

The *Engine oil pressure indicator* comes on when the engine oil pressure falls below the normal operating pressure. If this indicator comes on, stop the machine immediately and correct the problem.

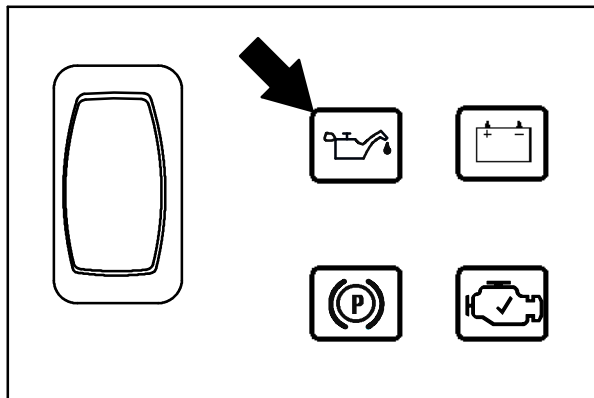

**CHECK ENGINE INDICATOR**

The *Check engine indicator* comes on when the engine control system detects a fault during machine operation.

If this indicator comes on, contact a Tennant service representative.

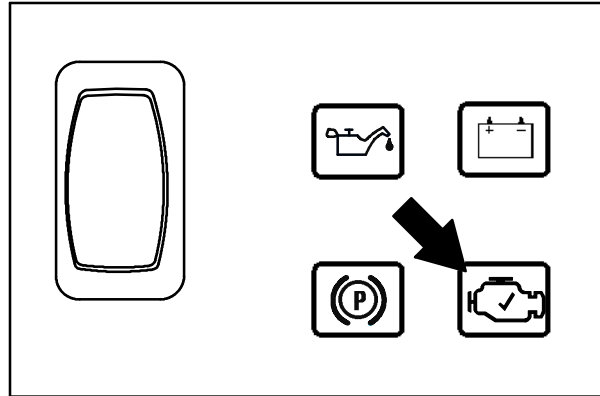

**PARKING BRAKE INDICATOR (OPTION)**

The *parking brake indicator* comes on when the parking brake is engaged.

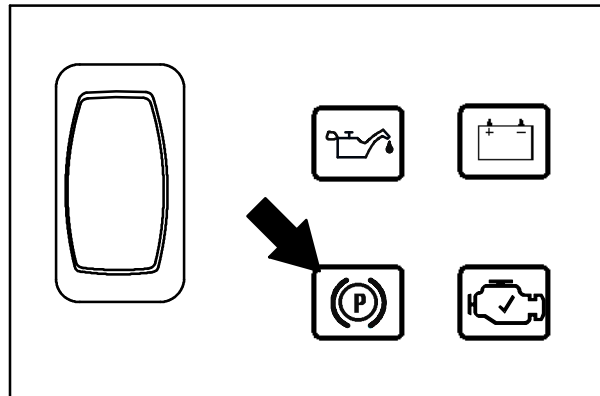

## OPERATION

### SETTING THE ENGINE SPEED

The engine speed is controlled automatically when the *1-STEP Scrub button* is pressed. When not scrubbing, press the *Engine Speed button* to increase the engine RPM for increased travel speed. Press the *Engine Speed button* again to reduce the engine RPM. The two lights above the button indicate engine speed setting. When one light is lit the engine is in the low setting. When two lights are lit the engine is in the high setting.

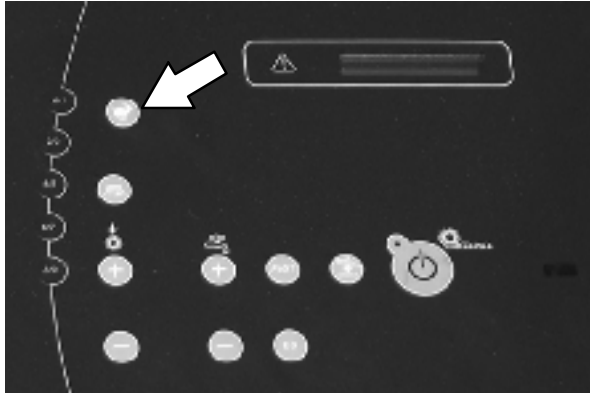

### SIDE BRUSH (OPTION)

The side brush allows users to scrub difficult to reach corners and areas near walls. The side brush also widens the scrubbing path.

With the *1-STEP Scrub button* activated, press the *Side brush button* to lower and start the side brush. The light next to the button will come on. When finished using the side brush, press the button again to raise and stop the side brush. The light next to the button will turn off. The machine will default to the last setting used when it is powered on or off.

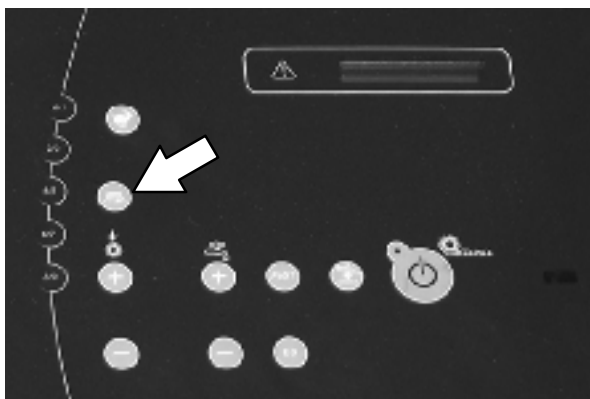

### FUEL INDICATOR

#### GASOLINE MACHINES

For gasoline machines, the *Fuel indicator* displays the amount of fuel left in the tank. The fault indicator will flash and a low fuel message will appear when the tank is near empty.

*NOTE: Do not use leaded fuels. Leaded fuels will permanently damage the system oxygen sensor and catalytic converter.*

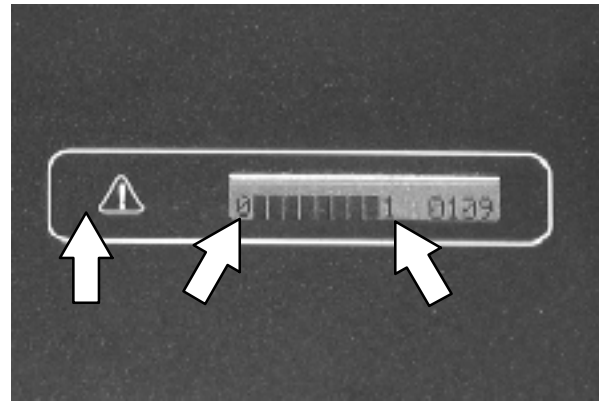

#### LPG MACHINES

For LPG machines, the *Fuel indicator* does NOT display the amount of fuel in the LPG tank. It will display all the indicator bars to show that some fuel is in the tank. When the LPG tank is near empty, the fault indicator will flash and a low fuel message will appear.

The LPG *fuel gauge* on the tank displays the amount of fuel in the LPG tank.

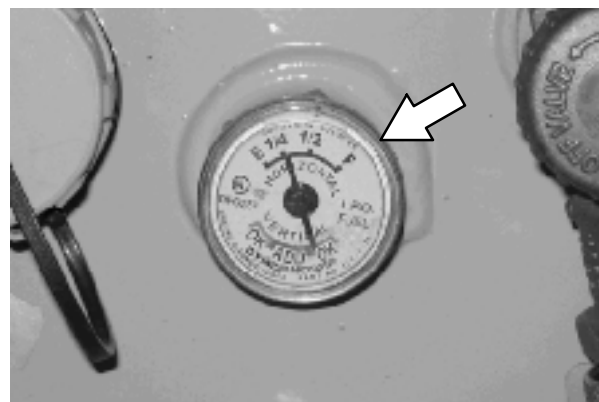

**HOURLY METER**

The *Hour meter* records the hours the machine was operated. Use this information to determine machine service intervals.

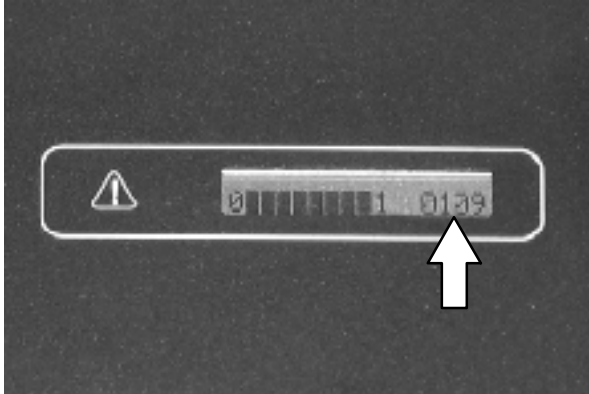

**OPERATING LIGHTS**

Push the top of the *Operating / hazard light switch* to turn on the headlights and taillights. Return the light switch to the center position to turn off the lights.

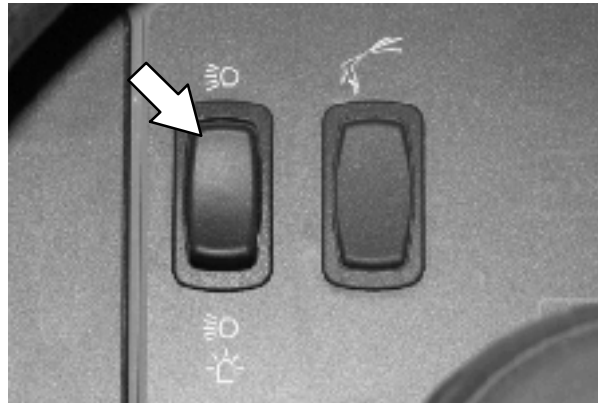

**SUPERVISOR CONTROL BUTTONS**

The *Supervisor Control buttons* are for accessing the configuration and diagnostic modes. Only properly trained service personnel and TENNANT representatives should access these modes.

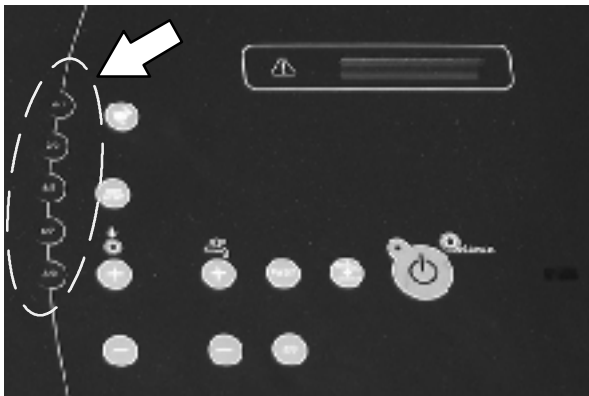

**HAZARD LIGHT (OPTION)**

Press the bottom of the *Operating / hazard light switch* to turn on the hazard light, headlights, and taillights. Return the light switch to the center position to turn off the lights.

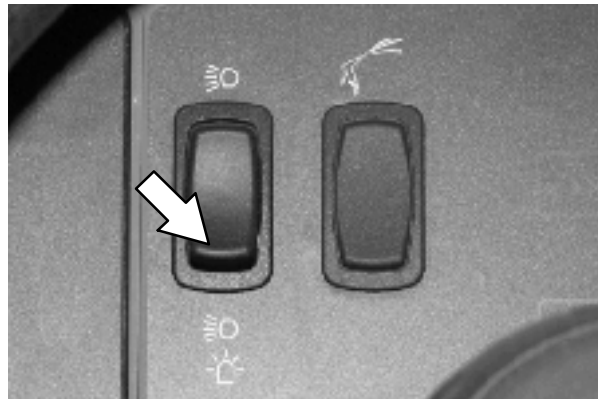

## OPERATION

### OPERATOR SEAT

The operator seat has three adjustments: backrest angle, operator weight, and front to back.

The backrest adjustment knob adjusts the angle of the backrest.



Increase angle: Turn the angle adjustment knob counterclockwise.

Decrease angle: Turn the angle adjustment knob clockwise.

The weight adjustment knob controls the firmness of the operator seat.

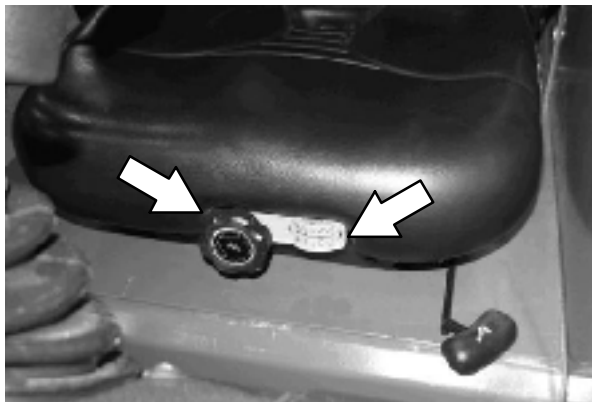

Increase firmness: Turn the weight adjustment knob clockwise.

Decrease firmness: Turn the weight adjustment knob counterclockwise.

Use the gauge next to the weight adjustment knob to help determine seat firmness for the operator.

The front-to-back adjustment lever adjusts the seat position.

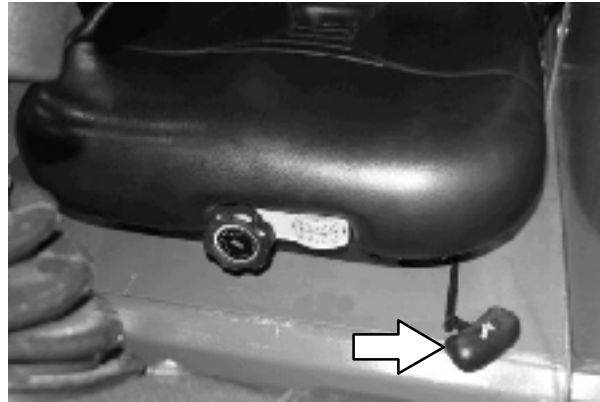

Adjust: Pull the lever out and slide the seat to the desired position. Release the lever to lock the seat into place.

### SEAT BELTS

Always fasten and adjust the *seat belts* before operating the machine.



### STEERING COLUMN TILT KNOB

1. Pull the *Steering column tilt knob* and adjust the steering column to the desired height.
2. Release the *Steering column tilt handle*.

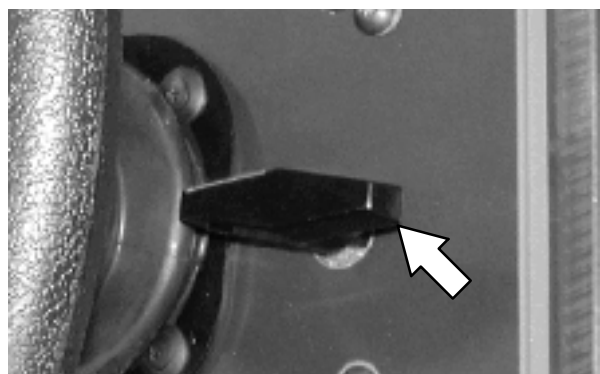



**BRAKE PEDAL**

Press the *Brake pedal* to stop the machine.

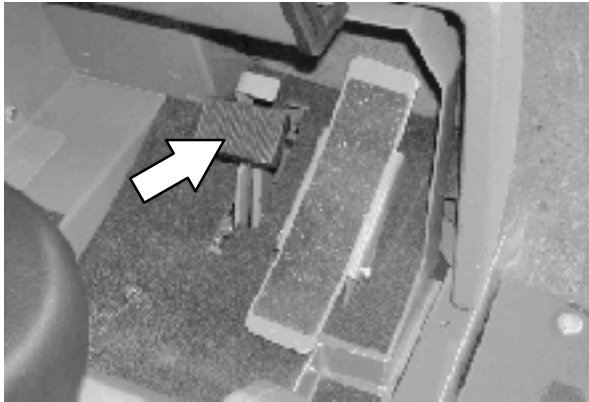

**PARKING BRAKE PEDAL**

Press the *Brake pedal* down as far as possible and use toe to lock the *Parking brake pedal* into place. Press the *Brake pedal* to release the parking brake. The *Parking brake pedal* will return to the unlocked position.

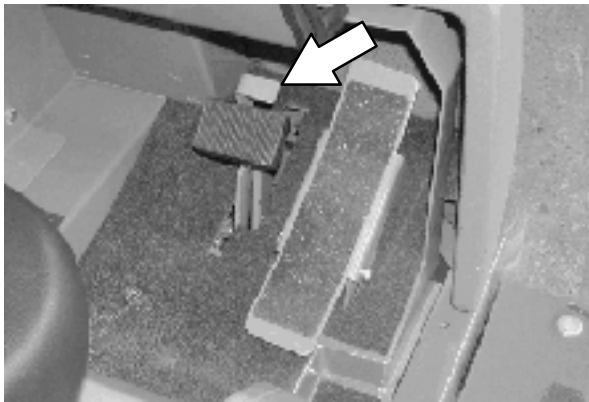

**DIRECTIONAL PEDAL**

Press the top of the *Directional pedal* to move forward and the bottom of the pedal to move backward. The backup lights will come on when the machine is in reverse. The pedal returns to the neutral position when it is released.

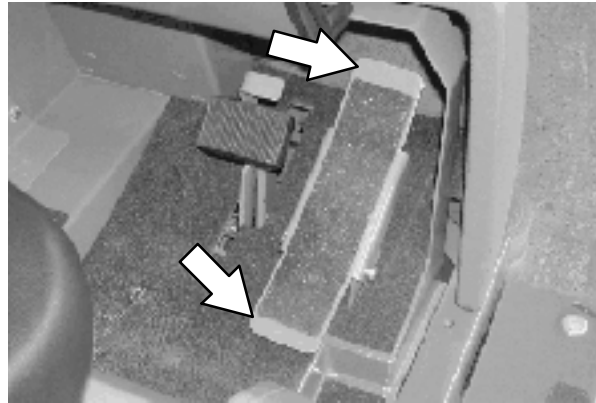

*NOTE: An audible alarm will sound and the backup light will flash when backing the machine if equipped with the optional backup alarm.*

**SQUEEGEE PROTECTORS (OPTION)**

The rear and side squeegee protectors help protect the rear squeegee from being damaged.

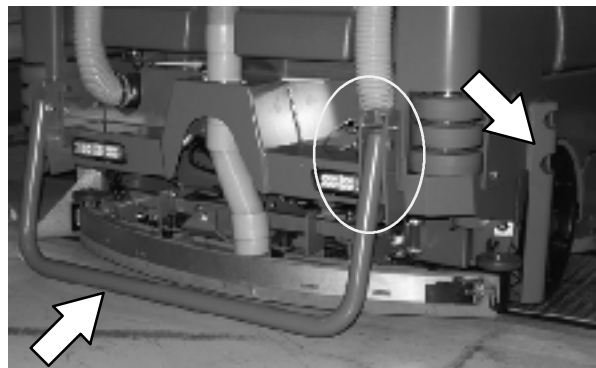

To engage the rear squeegee protector, pull the pin, lower the protector bar, and reinsert the pin.



# OPERATION

## HOW THE MACHINE WORKS

This machine can effectively scrub dirty floors. The *1-STEP Scrub button* makes it possible to immediately begin scrubbing by operating all the scrubbing functions.

When in the conventional Scrub mode, a water and detergent mixture is used to scrub the floor.

When in the optional FaST (Foam scrubbing) mode, the FaST scrubbing system mixes the FaST-PAK concentrate with a small amount of water, creating a large volume of expanded wet foam. The FaST system can be used with all scrubbing applications.

When in the optional ES (Extended Scrub) mode, the dirty solution in the recovery tank is filtered through the ES system and returned to the solution tank for reuse. Detergent is then injected into the returned solution to revitalize the cleaning capability of the solution.



## BRUSH AND PAD INFORMATION

For best results, use the correct brush type for the cleaning application. Listed below are the brushes and the applications for which each is best suited.

*NOTE: The amount and type of soilage play an important role in determining the type of brushes to use. Contact a Tennant representative for specific recommendations.*

**Nylon brush (Disk)\*** – Softer nylon bristles are recommended for scrubbing coated floors. Cleans without scuffing.

**Polyester brush (Cylindrical)** – Softer general purpose polyester bristles gently clean while scrubbing. Perfect for sensitive floor surfaces. Polyester does not absorb water so it is preferred over Nylon in wet applications.

**PolyPro brush (Cylindrical)** – Heavy duty polypropylene bristles provide a more aggressive cleaning performance and can more easily lift compacted dirt, debris, and sand while offering excellent scrubbing performance.

**Polypropylene brush (Cylindrical and Disk)\*** – General purpose polypropylene bristles lift lightly compacted dirt without scuffing high-gloss coated floors.

**Super AB brush (Cylindrical and Disk)\*** – Nylon fiber impregnated with abrasive grit to remove stains and compacted dirt. Aggressive action on any surface. Performs well on buildup, grease, or tire marks.

*\* This brush is also available for the side brush.*

**Stripping pad** – This brown pad is for stripping floors. Quickly and easily cuts through old finish to prepare the floor for recoating.

**Scrubbing pad** – This blue pad is for scrubbing floors. Removes dirt, spills, and scuffs. Leaves a clean surface ready for re-coating.

**Buffing pad** – This red pad is for buffing floors. Quickly cleans and removes scuff marks while polishing the floor to a high gloss.

**Polishing pad** – This white pad is for polishing floors. Maintains a high gloss. Use for buffing very soft finishes and lower traffic areas, and polishing soft waxes on wood floors.

**High productivity pad** – This black pad is for aggressively stripping floor finishes/sealers or for very heavy-duty scrubbing. *This pad can only be used with the grip pad driver, not the tufted pad driver.*

**Surface preparation pad** – This maroon pad is for very aggressive floor stripping without chemicals.

**Grip pad driver** – The grip-face backing allows pads to be fully used and holds pads in place without penetrating the pad. The spring-activated centering device works with all Tennant pads and allows for fast, easy pad replacement.



**Tufted pad driver** – Standard pad driver has short bristles, or “tufts,” on the back to hold the pad in place. This driver works with all Tennant pads except the black high productivity pad.

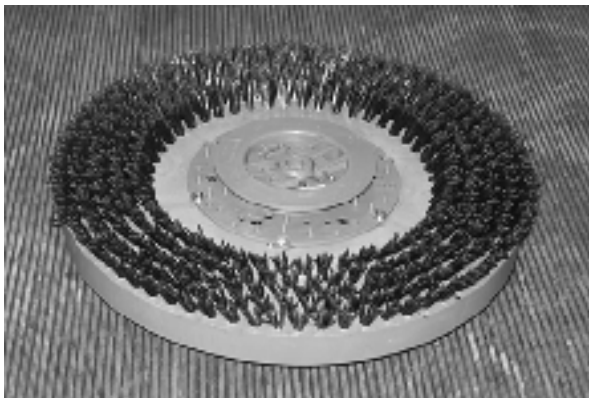

---

**WHILE OPERATING THE MACHINE**

---

Pick up oversized debris before scrubbing. Pick up wire, string, twine, large pieces of wood, or any other debris that could become wrapped around or tangled in the brushes.

Drive as straight a path as possible. Avoid bumping into posts or scraping the sides of the machine. Overlap the scrub paths by several centimeters (a few inches).

Avoid turning the steering wheel too sharply when the machine is in motion. The machine is very responsive to the movement of the steering wheel. Avoid sudden turns, except in emergencies.

Adjust the machine speed, brush pressure, and solution flow as required when scrubbing. Use the lowest brush pressure and solution flow settings for best performance. If the machine is equipped with the FaST system, use the FaST system for the best scrubbing results.

Keep the machine moving to prevent damaging floor finishes.

If poor cleaning performance is observed, stop cleaning and refer to *MACHINE TROUBLESHOOTING* in this manual.

Perform the Daily Maintenance Procedures after each use (see *MACHINE MAINTENANCE* in this manual).

Drive the machine slowly on inclines. Use the brake pedal to control machine speed on descending inclines. Scrub with the machine up inclines rather than down inclines.

**FOR SAFETY: When using machine, go slow on inclines and slippery surfaces.**

The maximum rated incline for scrubbing with the machine is 8° or 14%. The maximum rated incline during transport of the machine is 10° or 18%.

# OPERATION

---

## PRE-OPERATION CHECKLIST

---

- Check the hydraulic fluid level.
- Check the fuel level.
- Check the condition of the main brushes. Remove string, banding, plastic wrap, or other debris wrapped around the brushes.
- Cylindrical brushes: Check that the debris tray is empty and clean.
- Check the main brush compartment right skirts, seals, and squeegee for damage and wear.
- Side Brush Option: Check the condition of the brush. Remove string, banding, plastic wrap, or other debris wrapped around the brush.
- Side Brush Option: Check the condition of the side brush squeegee.
- Check the radiator and hydraulic cooler fins for debris.
- Check the engine coolant level.
- Check the engine oil level.
- Check the main brush compartment left skirts, seals, and squeegee for damage and wear.
- Check the left solution tank cover seal for damage and wear.
- Check the recovery tank cover seal for damage and wear.
- Clean the vacuum fan debris filter.
- Drain and clean the recovery tank.
- ES Option: Drain and clean the solution tank, float sensor, and ES filter.
- Check the right solution tank cover seal for damage and wear.
- Check the squeegee hose for debris or blockage.
- Check the squeegees for damage, wear, and deflection adjustment.
- FaST Scrubbing: Check the FaST-PAK concentrate agent level. Replace carton as needed. See the INSTALLING THE FaST-PAK CARTON section of the manual.
- FaST Scrubbing: Ensure all conventional cleaning agents are drained and rinsed from the solution tank.
- FaST Scrubbing: Ensure the solution tank is filled with **clear cool water only**.
- Check the headlights, taillights, and safety lights.
- Check the brakes and steering for proper operation.
- Check the service records to determine maintenance requirements.

## CHANGING THE LPG TANK

**FOR SAFETY: Before leaving or servicing machine, stop on level surface, set parking brake, and turn off machine.**

1. Open the side access door.
2. Close the LPG tank service valve.

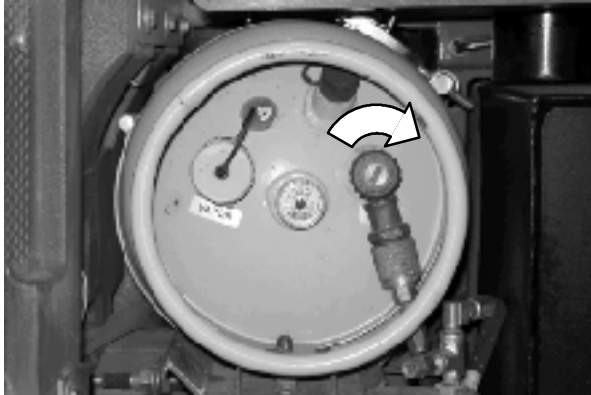

3. Start the machine and operate the engine until it stops from lack of fuel. Turn off the machine.
4. Lift the operator seat open and engage the seat latch so the seat remains open.

**FOR SAFETY: When servicing machine, keep flames and sparks away from fuel system service area. Keep area well ventilated.**

5. Put on gloves and remove the quick disconnect tank coupling.

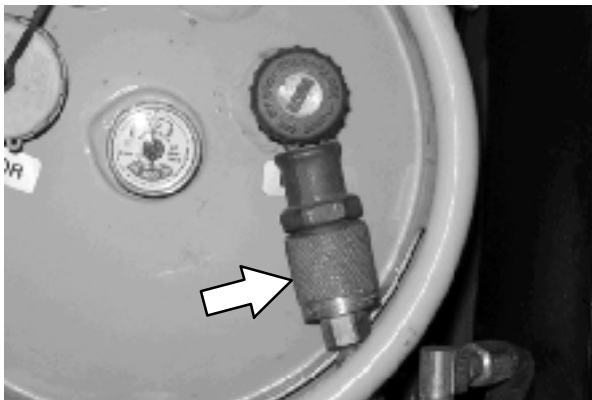

6. Disengage the mounting strap and remove the empty LPG fuel tank.

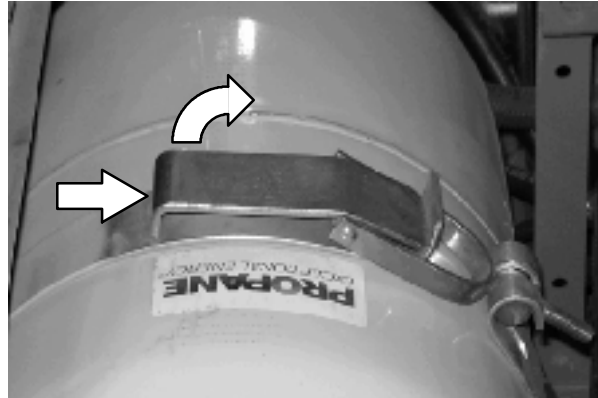

7. Align the hole in the tank collar with the centering pin and carefully place the full LPG tank onto the tray. Secure the tank with mounting strap.

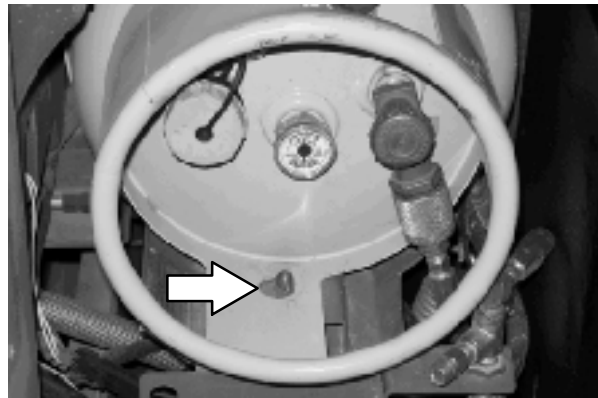

8. Connect the LPG fuel line to the tank service coupling. Make sure the tank service coupling is clean and undamaged and that it matches the fuel line coupling.
9. Slowly open the tank service valve and check for leaks. If a leak is found, immediately close the service valve and inform the appropriate personnel.

## OPERATION

### STARTING THE MACHINE

1. LPG powered machines: Slowly open the liquid service valve.

*NOTE: Opening the service valve too quickly may cause the service check valve to stop the flow of LPG fuel. If the check valve stops the fuel flow, close the service valve, wait a few seconds, and slowly open the valve again.*

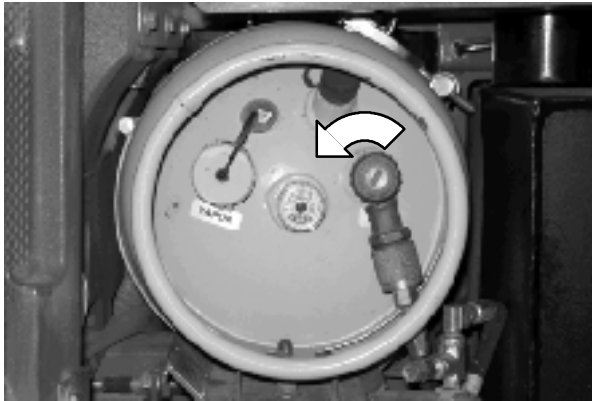

2. Sit in the operator seat and press the brake pedal or set the parking brake.

**FOR SAFETY: When starting machine, keep foot on brake and directional pedal in neutral.**

3. Turn the ignition switch key until the engine starts.

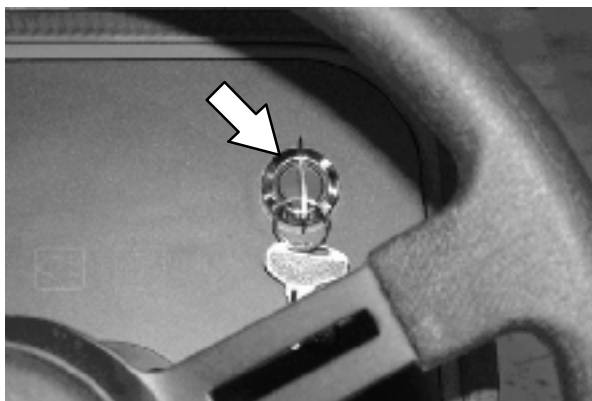

*NOTE: Do not operate the starter motor for more than 10 seconds at a time or after the engine has started. Allow the starter to cool 15-20 seconds between starting attempts or damage to the starter motor may occur.*

4. Allow the engine and hydraulic system to warm up for three to five minutes.



**WARNING: Engine emits toxic gases. Severe respiratory damage or asphyxiation can result. Provide adequate ventilation. Consult with your regulatory authorities for exposure limits. Keep engine properly tuned.**

### TURNING OFF THE MACHINE

1. Stop the machine and turn off all scrubbing functions.
2. Turn the ignition switch key counter clockwise to turn off the machine. Remain in the operator seat until the engine is off.



**CAUTION: LPG engine will run for a few seconds after key is turned off. Apply parking brake before leaving machine.**

*NOTE: To protect engine emission components on LPG powered machines, the engine will continue to operate for a few seconds after the ignition switch is turned off.*

**FOR SAFETY: Before leaving or servicing machine, stop on level surface, set parking brake, and turn off machine.**

---

**FILLING THE SOLUTION TANK**

---

**FOAM SCRUBBING (FaST MODE)**

**FOR SAFETY: Before leaving or servicing machine, stop on level surface, set parking brake, and turn off machine.**

1. Open either the left or right solution tank fill cover.
2. Fill the solution tank with only clean COOL WATER (less than 21°C / 70°F). DO NOT use hot water or add any conventional floor cleaning detergents or FaST system failure may result.



**WARNING: Flammable materials can cause an explosion or fire. Do not use flammable materials in tank(s).**

*NOTE: To install or change the FaST-PAK carton, see the REPLACING THE FaST-PAK CARTON section of the manual.*

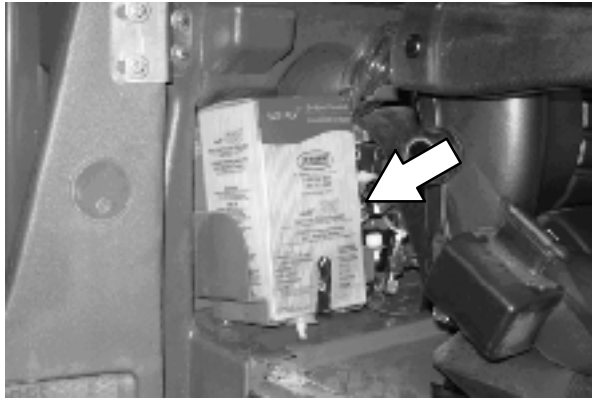

*NOTE: Do not use the FaST system when there are conventional cleaning detergents in the solution tank. Drain, rinse, and refill the solution tank with clear cool water before operating the FaST system. Conventional cleaning detergents may cause a FaST system failure.*

**CONVENTIONAL SCRUBBING MODE**

**FOR SAFETY: Before leaving or servicing machine, stop on level surface, set parking brake, and turn off machine.**

1. Open either the left or right solution tank fill cover.
2. Partially fill solution tank with water (not to exceed 60°C / 140°F). Pour the required amount of detergent into the solution tank. Fill the solution tank with water until the level is just below the indicator tab.



**WARNING: Flammable materials can cause an explosion or fire. Do not use flammable materials in tank(s).**



**ATTENTION: For Conventional Scrubbing, only use recommended cleaning detergents. Machine damage due to improper detergent usage will void the manufacturer's warranty.**

*NOTE: Pour a recommended foam control solution into the recovery tank if excessive foam appears. For specific detergent recommendations, contact a TENNANT representative.*

## OPERATION

### ES (EXTENDED SCRUB) MODE WITH AUTO-FILL

**FOR SAFETY:** Before leaving or servicing machine, stop on level surface, set parking brake, and turn off machine.

1. Connect the hose from the water source (not to exceed 60°C / 140°F) to the auto-fill connection.

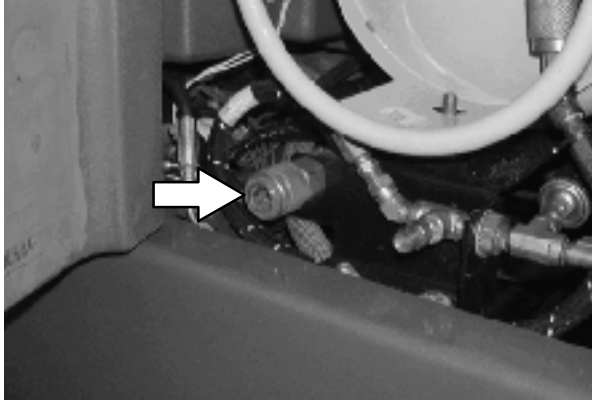

2. Turn the ignition switch to the on position (without starting) and turn on the water source. The auto-fill automatically fills the tanks to the proper level.
3. Fill the detergent tank with the proper detergent.

**ATTENTION:** For ES Scrubbing, only use recommended low-foaming cleaning detergents. Machine damage due to the use of improper detergent will void the manufacturer's warranty.

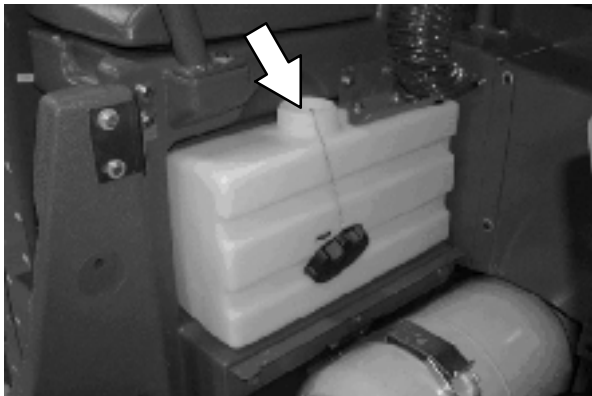

### ES (EXTENDED SCRUB) MODE - MANUALLY FILLING TANK

**FOR SAFETY:** Before leaving or servicing machine, stop on level surface, set parking brake, and turn off machine.

1. Open either the left or right solution tank cover and fill the solution tank with water (not to exceed 60°C / 140°F) until the level is just below the indicator tab.



2. Open the recovery tank cover and fill the recovery tank with water (not to exceed 60°C / 140°F) until the recovery tank is approximately half full.

**WARNING:** Flammable materials can cause an explosion or fire. Do not use flammable materials in tank(s).

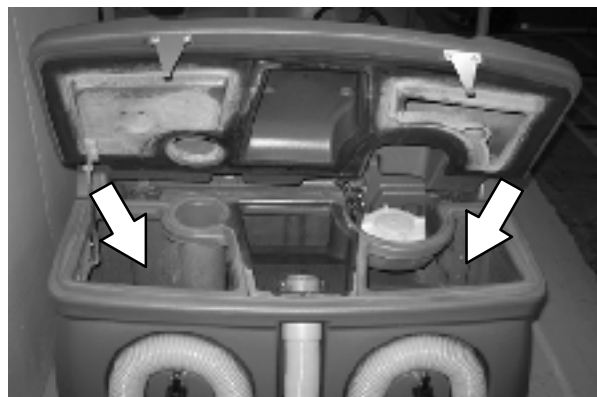



## SETTING SCRUB MODES

Before scrubbing, determine which scrub mode will be used (FaST, ES or conventional). Then set the scrub brush pressure and adjust the solution flow levels.

### SETTING FaST MODE

The *FaST button* enables the FaST system to come on when the *1-STEP Scrub button* is activated. The light next to the button will come on. The machine will default to the last setting used when it is powered on or off.

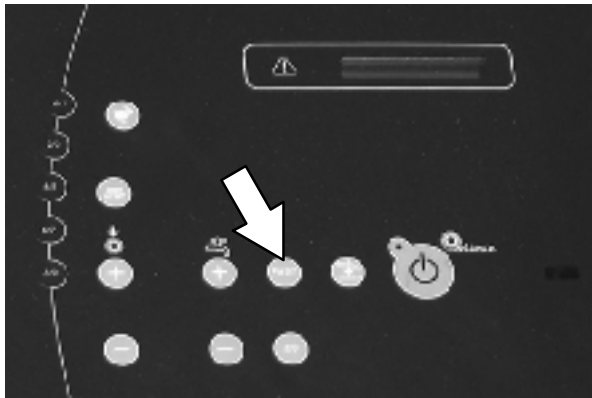

### SETTING ES (EXTENDED SCRUB) MODE

The *ES button* enables the ES system to come on when the *1-STEP Scrub button* is activated. The light next to the button will come on. The machine will default to the last setting used when it is powered on or off.

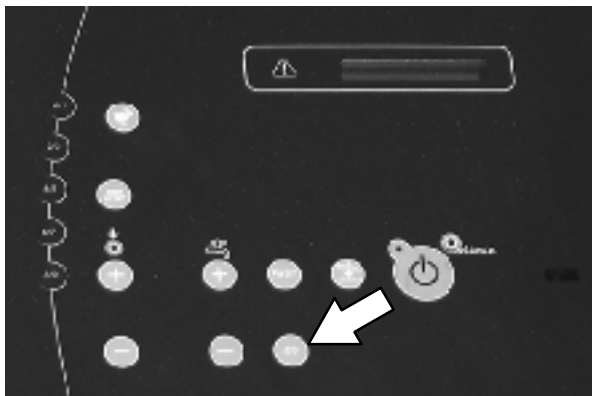

**NOTE:** When the ES system is turned on there is a slight delay before the ES pump begins operating.

## SETTING BRUSH PRESSURE

Under normal cleaning conditions, the brush pressure should be set to the minimum setting (the bottom light). Under heavy grime conditions, the brush pressure can be set to a higher setting. Travel speed and floor conditions will affect cleaning performance.

With the *1-STEP Scrub button* activated, press either the *Brush Pressure increase button (+)* or the *Brush Pressure decrease button (-)* to set the brush pressure for the surface being cleaned. If brushes are worn, it may be necessary to increase the brush pressure. The machine will default to the last setting used when it is powered on or off.

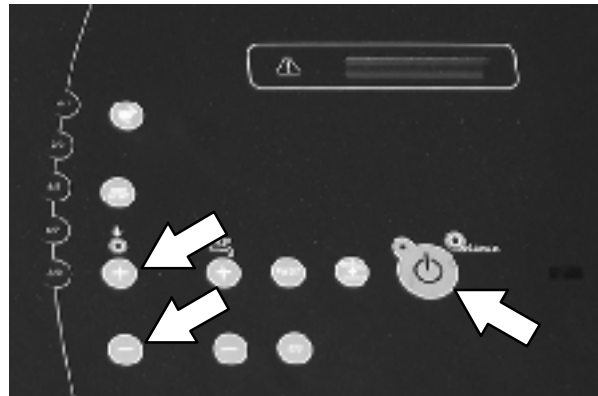

## OPERATION

### SETTING SOLUTION FLOW

With the *1-STEP Scrub* button activated, press either *Solution increase button (+)* or *Solution decrease button (-)* to set the solution flow level. Travel speed and floor conditions will affect scrubbing performance. The machine will default to the last setting used when the machine is powered on or off.

*NOTE: In the ES and FaST modes, the solution flow buttons control both the solution AND detergent flow levels.*

To turn off all solution and detergent flow, press the *Solution decrease button (-)* until all indicator lights are off.

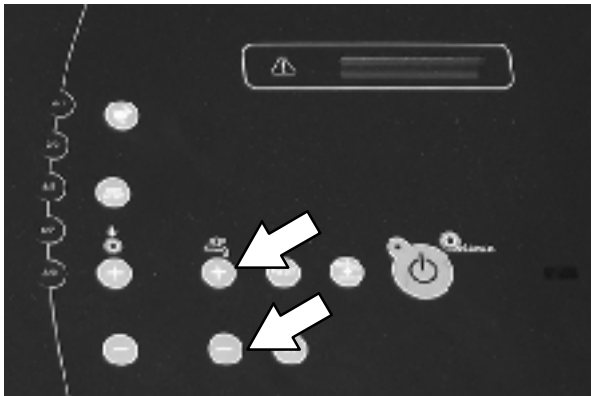

### CONVENTIONAL AND FaST SOLUTION FLOW

Under normal soilage conditions the solution flow level should be set to the lowest setting (the bottom light). Under heavy grime conditions, the solution flow level should be set to the higher settings (middle or top lights).

### ES (EXTENDED SCRUB) SOLUTION FLOW

***For ES machines, the detergent flow is turned off when the solution flow is in the lowest setting (one light).*** Under normal soilage conditions, the solution flow level should be alternated between the middle and lowest setting. The middle setting (two lights) allows solution AND detergent flow. The lowest setting (one light) allows solution flow WITHOUT adding detergent. Detergent does not have to be continuously added with the solution flow to attain effective scrubbing results.

## SCRUBBING

The *1-STEP Scrub button* operates all the scrubbing functions.

**FOR SAFETY: Do not operate machine, unless operator manual is read and understood.**

1. Start the machine.

*NOTE: Make sure the scrub modes / settings are set before scrubbing.*

2. Press the *1-STEP Scrub button*. The light on the button will come on. All the preset scrubbing functions will turn on.

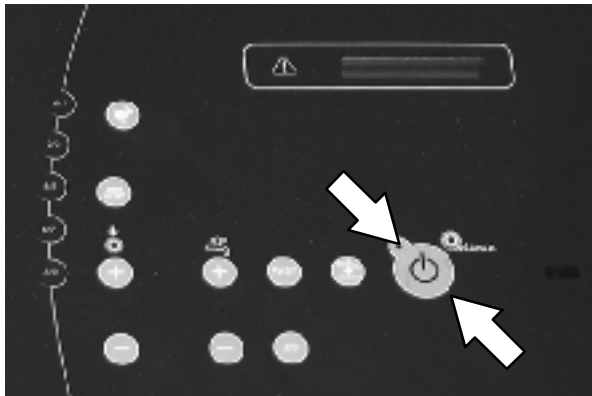

*NOTE: DO NOT turn on the FaST system during conventional scrubbing. Conventional cleaning detergents could cause a FaST system failure. Drain, rinse, and refill the solution tank with cool clean water before operating the FaST system.*

3. Release the parking brake, then press the *Directional pedal* to begin scrubbing.

**WARNING:** Flammable materials or reactive metals can cause an explosion or fire. Do not pick up.

**FOR SAFETY: When using machine, go slow on inclines and slippery surfaces.**

*NOTE: The squeegee automatically rises when the machine is driven backwards. This prevents damaging the squeegee.*

4. Release the *directional pedal* and press the *brake pedal* to stop the machine.
5. Press the *1-STEP Scrub button* to stop scrubbing. The light next to the button will go off and scrubbing functions will stop after a short delay.

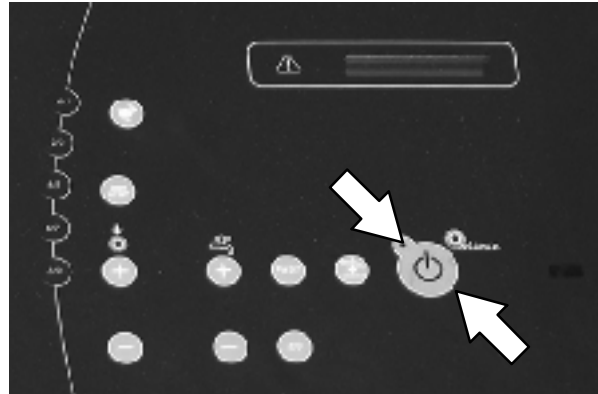

## OPERATION

### DOUBLE SCRUBBING

For heavily soiled areas, use the double scrubbing method.

Side brush option: Before double scrubbing, manually lock the side brush squeegee into the raised position. Pull the pin from the side brush squeegee bracket, manually raise the side squeegee to the upper position, then reinsert the brush pin.

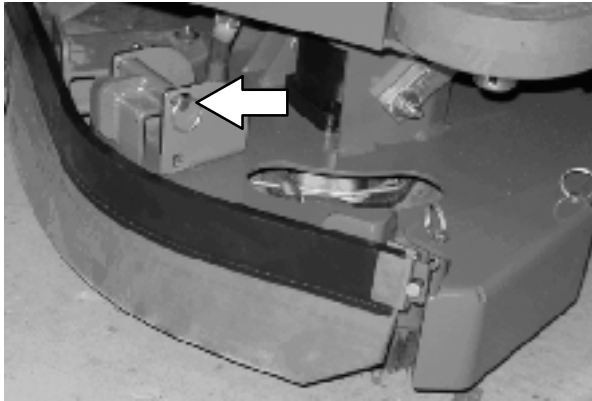

Press the *1-STEP Scrub* button, and then the *Scrub vacuum fan/squeegee* button. The light above the *Scrub vacuum fan/squeegee* button will turn off, the squeegee will rise, and the vacuum fan will stop operating. Scrub the heavily soiled area.

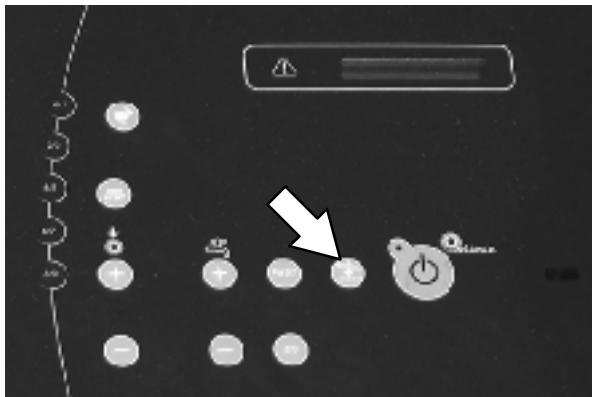

**FOR SAFETY: When using machine, go slow on inclines and slippery surfaces.**

Let the cleaning solution soak on the floor for 5-15 minutes. Then place the side squeegee into the lower position and lock into place with the pin.

Press the *Scrub vacuum fan/squeegee* button again to lower the squeegee and turn on the vacuum fan. The light above the button will come on. Scrub the floor a second time to pick up the cleaning solution.

**WARNING: Flammable materials or reactive metals can cause an explosion or fire. Do not pick up.**

*NOTE: To turn off the solution flow when scrubbing the area a second time, repeatedly press the *Solution decrease* button (-) until all lights above the button are off.*



*NOTE: Double scrubbing is not recommended in areas where the cleaning solution will run under racks or damage products.*

## WATER PICKUP MODE (NO SCRUBBING)

The machine can be used to pick up water or non-flammable liquid spills without scrubbing.

To pick up water or non-flammable liquid spills, make sure the *1-STEP Scrub button* is not activated. The light next to the button must be off.

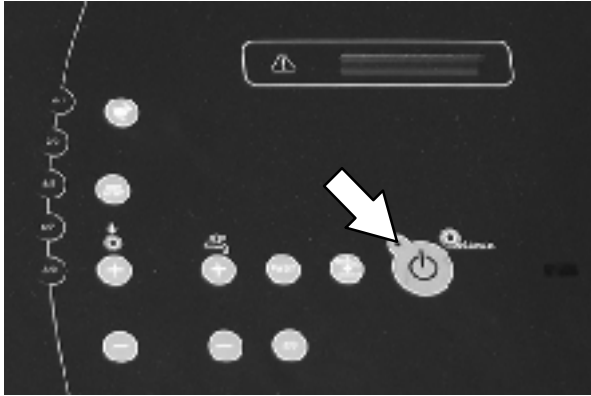

**⚠ WARNING: Flammable materials or reactive metals can cause an explosion or fire. Do not pick up.**

Press the *Scrub vacuum fan/squeegee button*. The light above the button will come on, the squeegee will lower, and the vacuum fan will start operating. Pick up the water or non-flammable liquid spill.

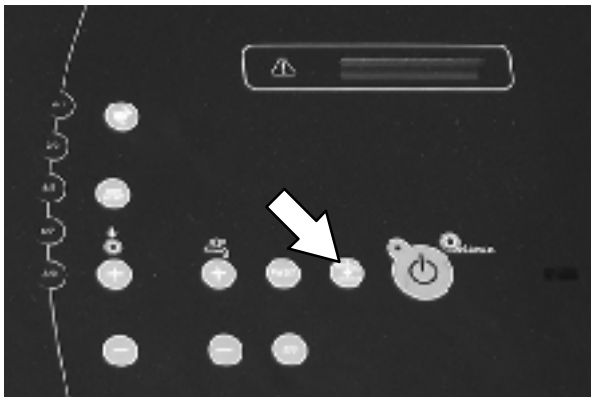

## OPERATION

### EMPTYING AND CLEANING THE DEBRIS TRAY - CYLINDRICAL SCRUB HEADS ONLY

1. Drive the machine to a debris dump site.

**FOR SAFETY: Before leaving or servicing machine, stop on level surface and set parking brake.**

2. Press the debris tray carriage release lever.



3. Pull the debris tray carriage open.

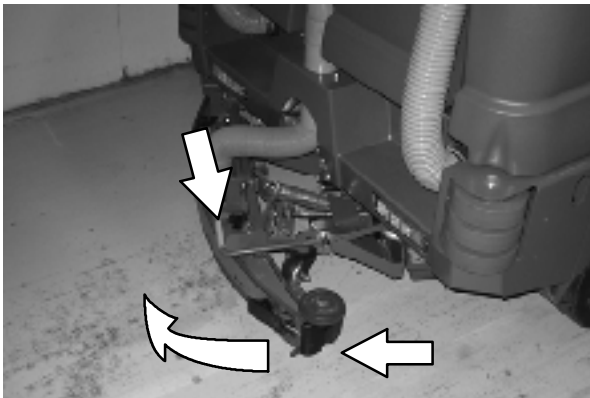

4. Pull the debris tray from the carriage.

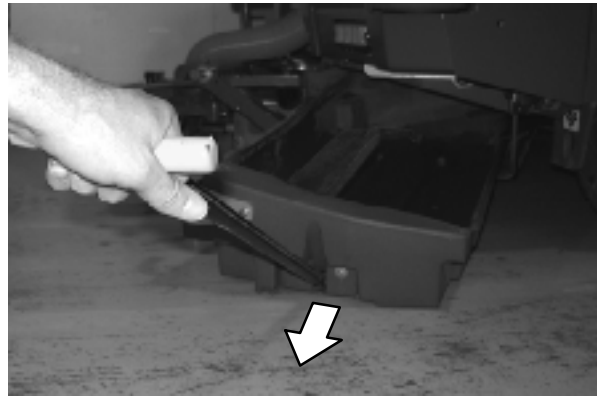

5. Empty the contents from the debris tray.

6. Remove the debris screen from the debris tray.

7. Rinse the debris screen and the debris tray.



8. Disconnect the vacuum hose from the rear coupling.

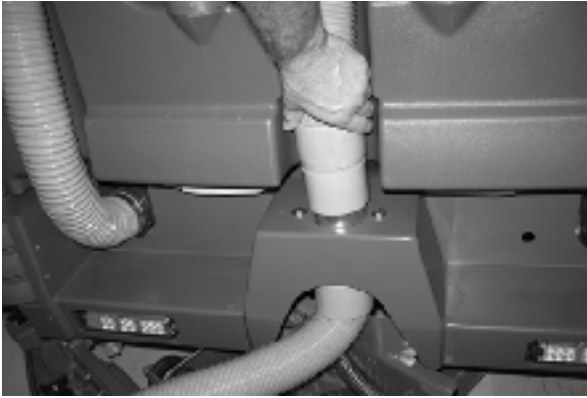

9. Spray water through the port located inside the vacuum coupling to rinse debris from the debris tray coupling.

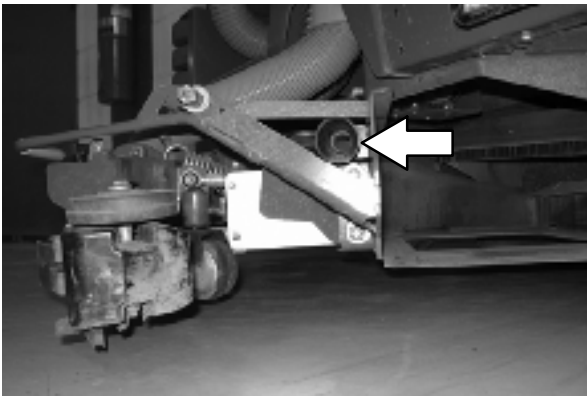
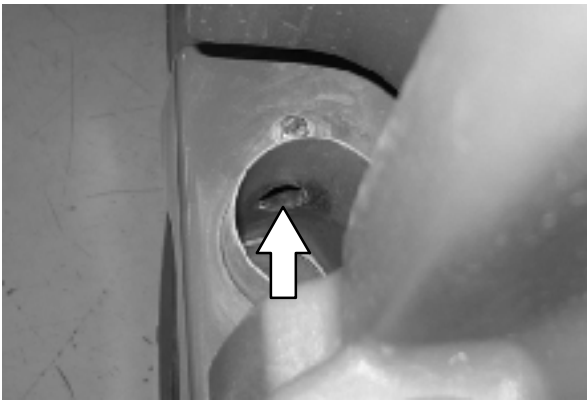

10. Reconnect the vacuum hose to the rear coupling.

11. Reinstall the debris screen into the debris tray.

12. Align the debris tray with the debris tray carriage, use the handle to guide the debris tray into the debris tray carriage, and slide the handle back into the debris tray.

13. Lift slightly on the debris tray carriage handle and push the debris tray carriage closed until it locks shut.

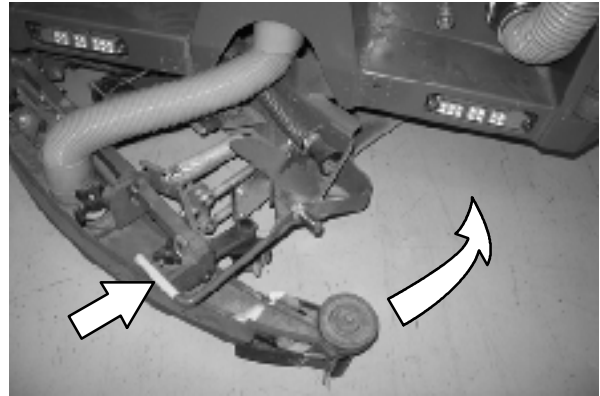

## OPERATION

### DRAINING AND CLEANING THE RECOVERY TANK

Drain and clean the recovery tank daily or when the recovery tank full indicator comes on.

Clean the outside of the recovery tank with vinyl cleaner.

**FOR SAFETY: Before leaving or servicing machine, stop on level surface, set parking brake, and turn off machine.**

### DRAINING THE RECOVERY TANK WITH THE DRAIN HOSE

1. Lift the recovery tank cover.



2. Place the recovery tank drain hose nozzle next to a floor drain.

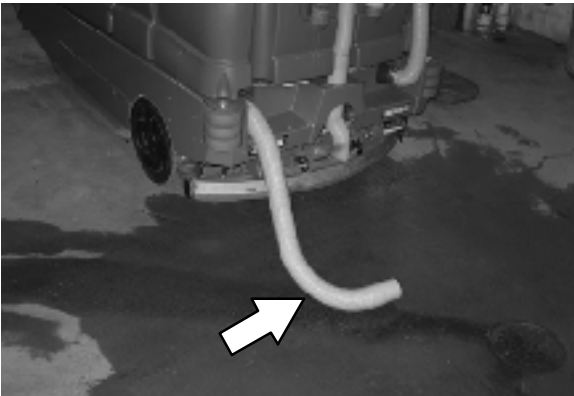

3. Open the recovery tank Variable Drain Valve.

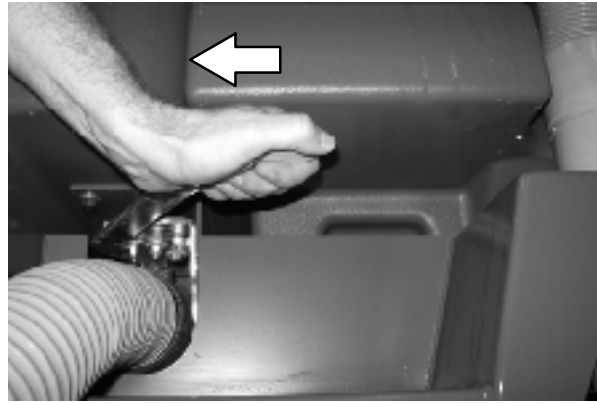

4. Rinse dirt and debris down through the drain hole in the demister tray and flush the vacuum hose.

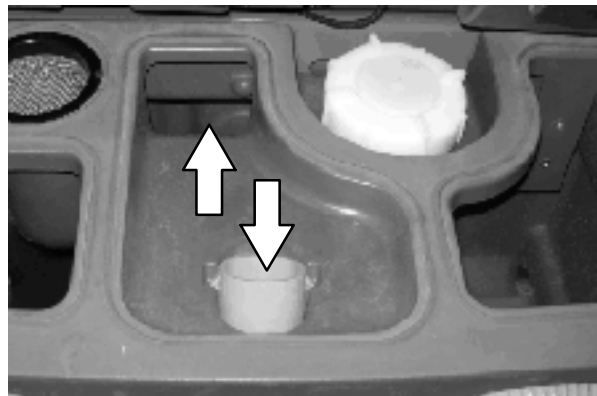

*NOTE: DO NOT use steam to clean tanks. Excessive heat can damage tanks and components.*

5. Remove the vacuum screen from the recovery tank and rinse the screen.

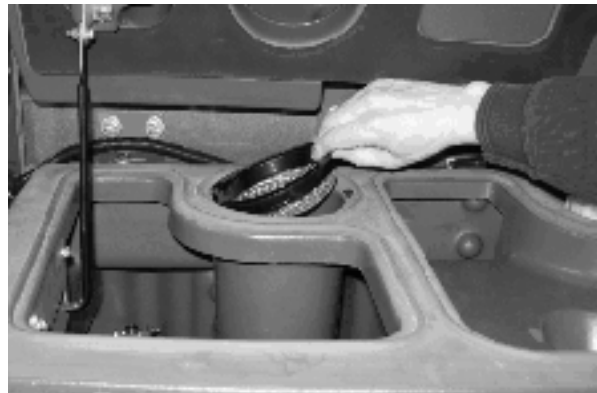



6. Rinse the float sensor.

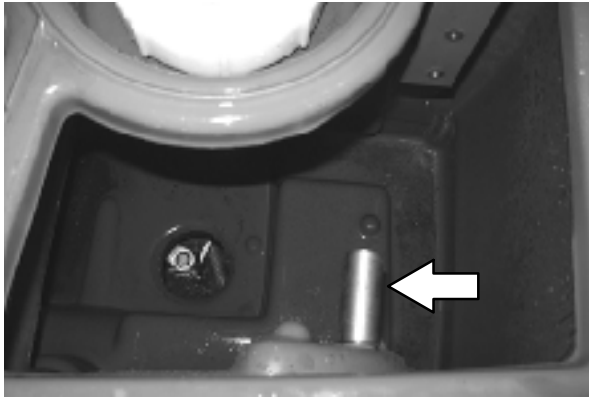

7. ES machines: Rinse the ES filter. If necessary, remove the ES filter from the recovery tank.

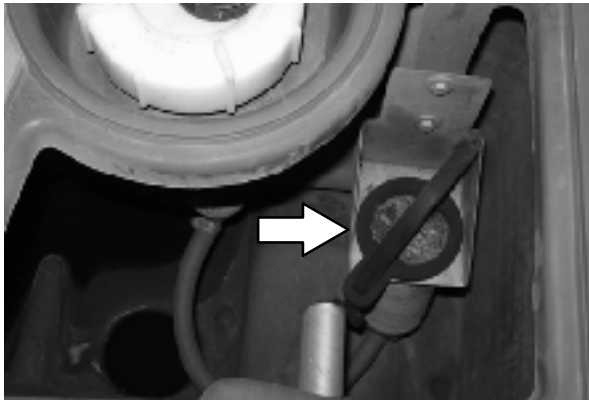

8. Rinse dirt and debris towards the recovery tank drain. Allow the recovery tank to drain.

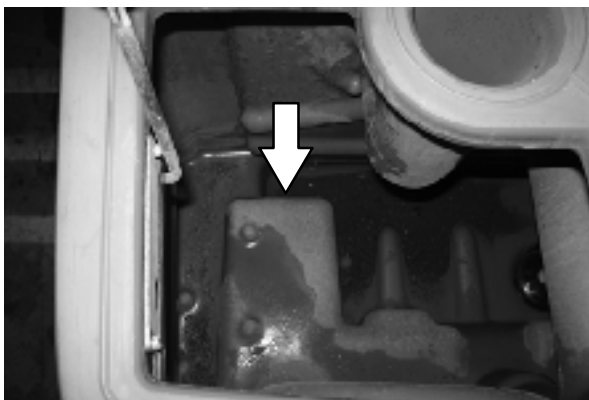

9. Close the recovery tank Variable Drain Valve.



10. Reinstall the recovery tank drain hose onto the back of the recovery tank and close the recovery tank cover.

**DRAINING THE RECOVERY TANK WITH THE DRAIN PLUG**

Use the drain plug to drain the recovery tank if the tank is draining slowly or if the drain hose is plugged.

1. Park the machine so the larger drain in the recovery tank is positioned over the disposal drain. Set the parking brake.

**FOR SAFETY: Before leaving or servicing machine, stop on level surface, and set parking brake.**

2. **Machines equipped with cylindrical scrub heads only:** To avoid water and debris from getting in the debris tray, open the debris carriage and remove the debris tray.

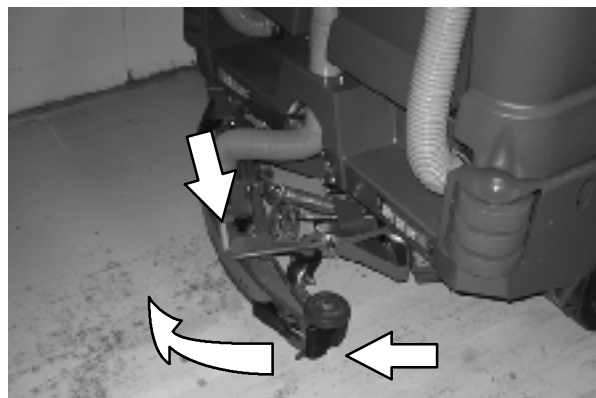

## OPERATION

3. Lift the drain plug handle and remove the drain plug from the tank.

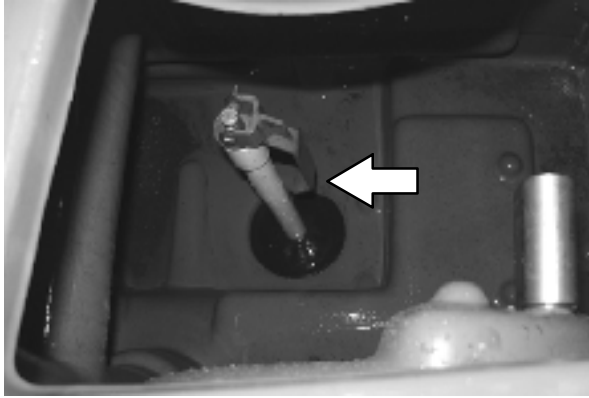

4. Open the recovery tank Variable Drain Valve.

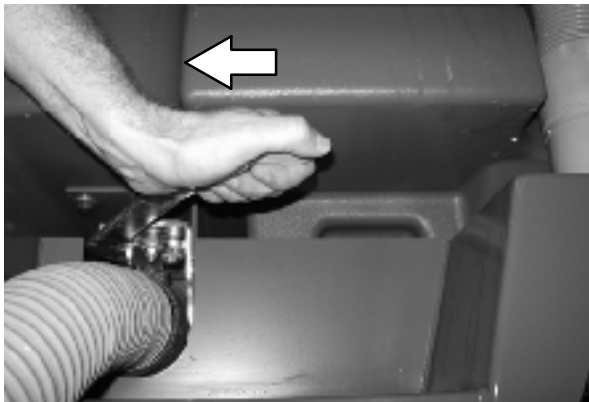

5. Remove the recovery tank drain hose from the back of the recovery tank, then rinse the dirt and debris from the hose into the tank.



6. Rinse dirt and debris out the open drain.

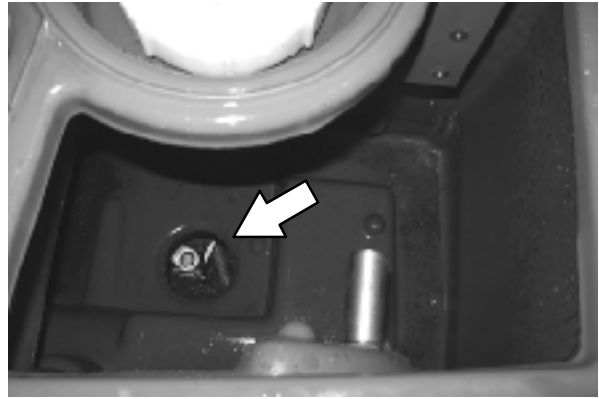

7. Clean the drain hole, then reinsert the drain plug. Push the handle down to tighten. Be sure the drain plug is fully seated before tightening.

*NOTE: If necessary, turn the handle clockwise for a tighter fit and counterclockwise for a looser fit.*

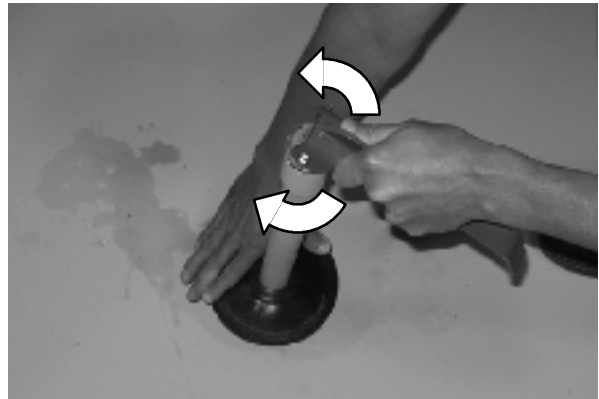

8. Close the recovery tank Variable Drain Valve.

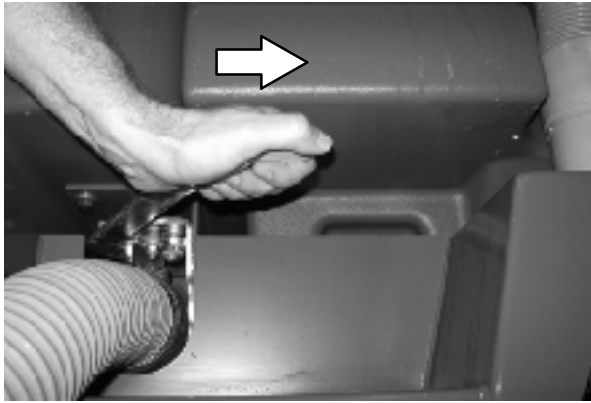

9. Reinstall the recovery tank drain hose onto the back of the recovery tank.
10. **Machines equipped with cylindrical scrub heads only:** Reinstall the debris tray into the debris tray carriage and close the carriage.
11. Close the recovery tank cover.

### DRAINING AND CLEANING THE SOLUTION TANK

The solution tank on non-ES machines does not require regular maintenance. If deposits form on the bottom of the tank, rinse the tank with a strong blast of warm water.

The solution tank on machines with the ES option should be drained and cleaned daily.

Clean the outside of the solution tank with vinyl cleaner.

**FOR SAFETY: Before leaving or servicing machine, stop on level surface, set parking brake, and turn off machine.**

1. Open the solution tank cover(s).

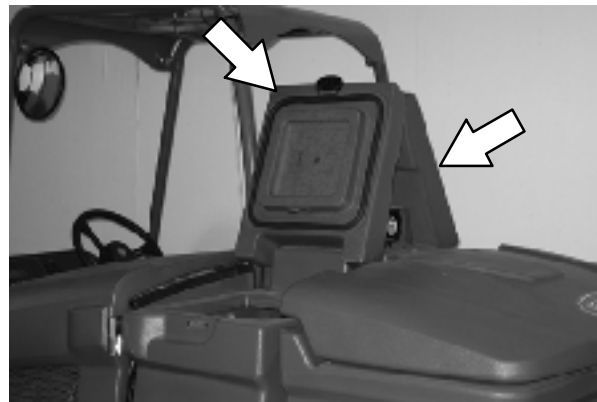

2. Place the solution tank drain hose nozzle next to a floor drain.

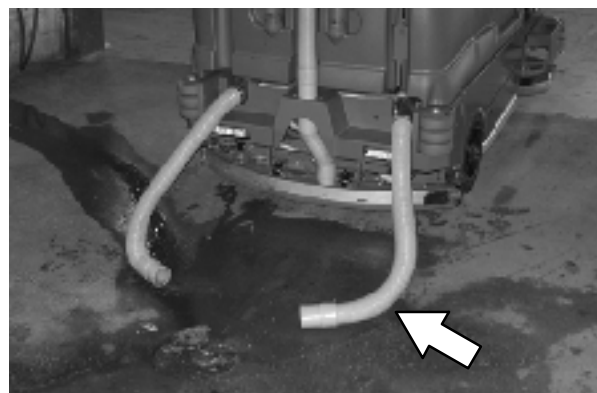

## OPERATION

3. Open the solution tank Variable Drain Valve.

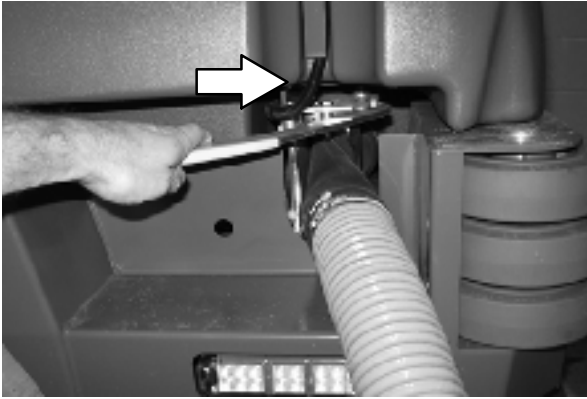

6. Close the solution tank Variable Drain Valve.

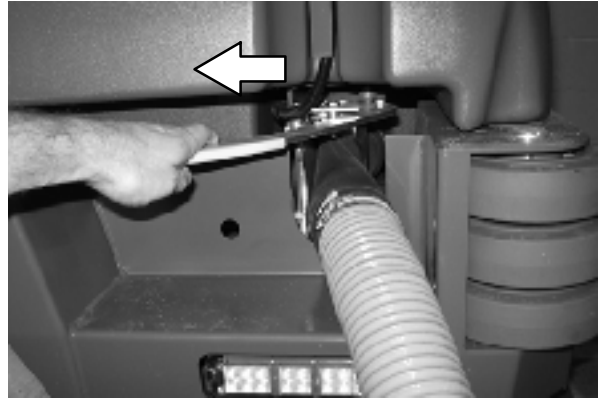

4. Rinse the solution tank. Flush dirt and debris toward the solution tank drain.

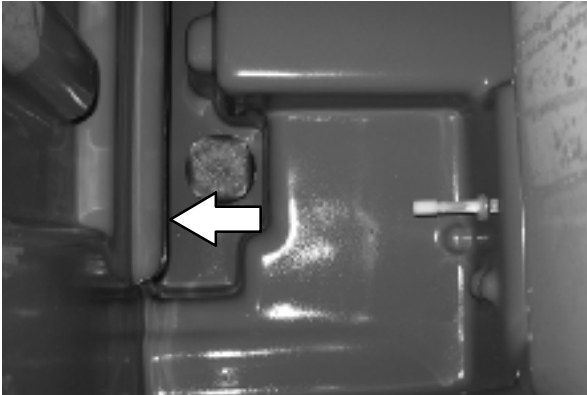

7. Reinstall the solution tank drain hose onto the back of the recovery tank.

8. Close the solution tank cover(s).

5. Rinse the float sensor and the screen filter. Allow the solution tank to drain.

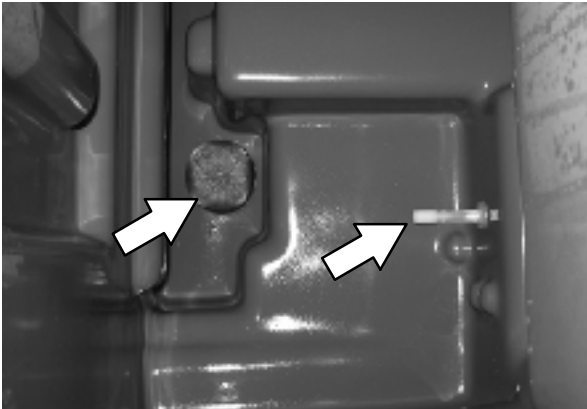

**FAULT INDICATOR(S)**

This machine is equipped with two visual indicators, a red indicator light and an LCD (liquid crystal display).

The red indicator light will blink continuously indicating that a fault has occurred.



The LCD will display a fault code. If there is more than one fault, each fault will alternately display.



All faults are also accompanied by an audible alarm to alert the operator a fault has occurred.

To reset the fault indicators, turn the machine off, then eliminate the cause of the fault. The fault indicator will reset when the machine is restarted.

Refer to the table below to determine the cause and remedy for the fault.

<b>Fault Code (Displayed in LCD)</b>	<b>Cause(s)</b>	<b>Result</b>	<b>Remedy</b>
F3: Clogged Hyd	Hydraulic filter is clogged	-	Replace hydraulic filter.
F6: Sol. Tank E.	Solution tank is empty	-	Fill solution tank.
F7: Rec. Tank Full	Recovery tank is full	Terminates scrubbing functions	Press the <i>Scrub vacuum fan/squeegee button</i> for one minute of extended water pickup. Empty recovery tank. ES models: activate the ES system to prevent this.
F8: High Eng Temp	Engine temperature is high	-	Shut off machine. Contact TENNANT service representative.
F9: High Hyd Temp	Hydraulic fluid temperature is high	-	Shut off machine. Contact TENNANT service representative.
F10: Low Fuel	Low fuel	-	Fill fuel tank (gasoline). Replace fuel tank (LPG)
F11: Open Scb Vac (Optional)	Scrub vacuum hose is not connected	-	Connect vacuum hose to squeegee assembly.
F12: Seat Sw Open (Optional)	Operator not in the seat while engine is running and parking brake not engaged	Engine will shut off	Engage parking brake before leaving the machine.

# OPERATION

## CONDITIONS / WARNINGS

Condition codes are typically caused by the operator attempting to activate modes that are unavailable. The code will appear in the LCD.



Refer to the table below to determine the cause of the condition.

Condition Code (Displayed in LCD)	Condition(s)	Description
C3: No FaST Mode	FaST mode unavailable	Only machines equipped with FaST system can be operated in FaST mode.
C4: No ES Mode	ES mode unavailable	Only machines equipped with ES system can be operated in ES mode.
C5: No ES/FaST	ES and FaST systems unavailable	Only machines equipped with ES or FaST system can be operated in these modes.
C6: No Side Brush	Side brush unavailable	Side brush not allowed to operate by itself.

**OPTIONS**

**SPRAY NOZZLE (OPTION)**

The spray nozzle is used to clean the machine and surrounding areas. The solution tank provides a water/solution supply for the spray nozzle. A wand is included with the spray nozzle.

*NOTE: Do NOT get water on electronic components when using the spray nozzle to clean the machine.*

**FOR SAFETY: Before leaving or servicing machine, stop on level surface, set parking brake, and turn off machine.**

1. Turn the key to the on position (without starting the machine).

*NOTE: The spray nozzle can be operated while the engine is running, but it is recommended to turn the engine off while using the spray nozzle.*

2. Press the top of the *Spray nozzle switch* to turn on the water supply. The light on the switch will come on when the spray nozzle is activated.

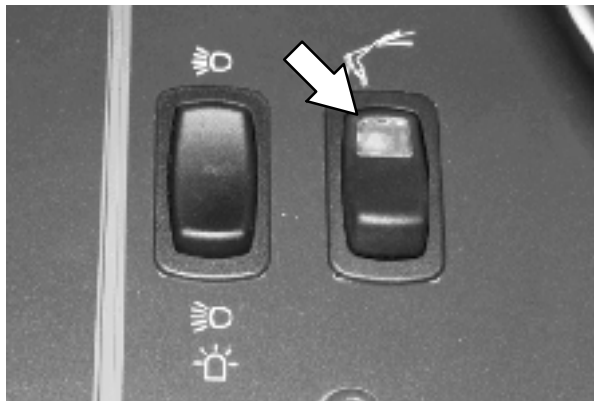

3. Remove the spray nozzle from the storage area and clean as required.

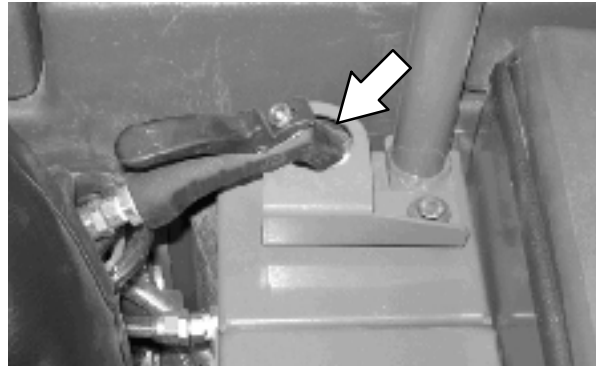

**FOR SAFETY: When using pressurized air or water, wear eye protection.**

4. If cleaning a hard to reach area, install the wand onto the spray nozzle.



5. Twist the off/on knob to turn on the wand.

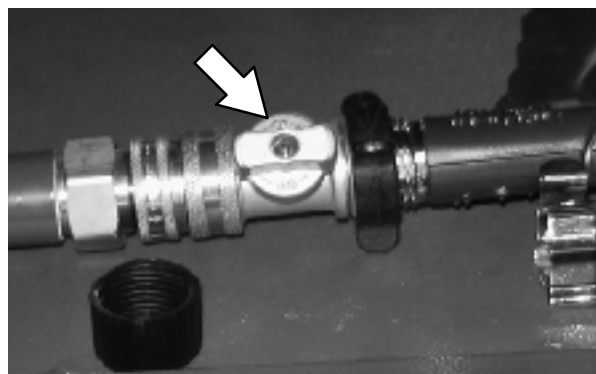

6. When finished cleaning, place the spray nozzle and wand back into their storage locations.

7. Press the bottom of the *Spray nozzle switch* to turn off the water supply.

## OPERATION

### VACUUM WAND (OPTION)

**FOR SAFETY: Before leaving or servicing machine, stop on level surface, set parking brake, and turn off machine.**

1. Remove the vacuum wand sections and hose from the storage bag located on top the recovery tank cover.
2. Disconnect the vacuum hose from the rear coupling and attach the wand hose.



3. Assemble the wand and nozzle.



4. Start the machine.



**WARNING: Engine emits toxic gases. Severe respiratory damage or asphyxiation can result. Provide adequate ventilation. Consult with your regulatory authorities for exposure limits. Keep engine properly tuned.**

5. Verify that the *1-STEP Scrub button* is off. The light next to the button will be off.

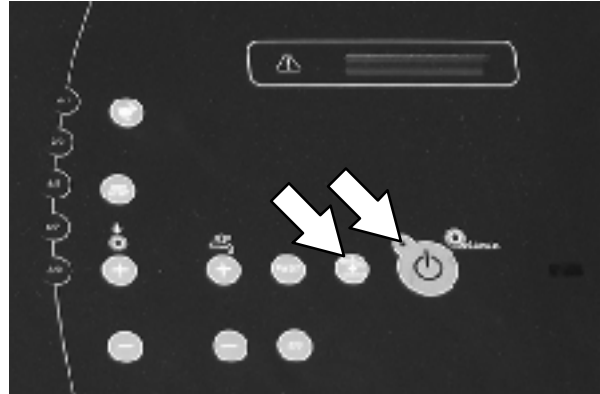

6. Press the *Scrub vacuum fan/squeegee button*. The light above the button will turn on and the vacuum fan will start operating.

**NOTE: The squeegee will lower.**

7. Clean the spill or debris.



8. When finished vacuuming, press the *Scrub vacuum fan/squeegee button* to turn off the vacuum. The light above the button will turn off.
9. Turn off the machine.
10. Disassemble the vacuum wand sections and hose and return them to the storage bag.
11. Reattach the vacuum hose to the rear coupling.



**POWER WAND (OPTION)**

The power wand uses both the vacuum and solution systems. The power wand allows the user to scrub floors that are out of reach of the machine.

**FOR SAFETY: Before leaving or servicing machine, stop on level surface, set parking brake, and turn off machine.**

1. Remove the power wand equipment from the storage bag on top the recovery tank cover.
2. Remove the squeegee suction hose from the top of the rear squeegee assembly.
3. Connect the vacuum wand hose and the squeegee vacuum hose with the adapter.

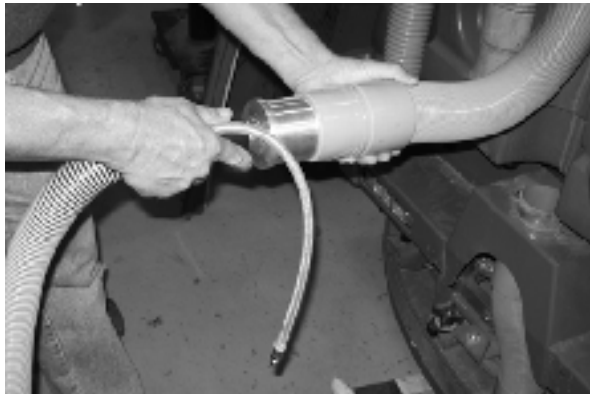

4. Attach the solution hose to the quick-disconnect fitting. Push the connector in until it stops. Pull on the hose to ensure it is connected.



5. Attach the other ends of the solution and vacuum hoses to the power wand.



6. Start the machine.

**WARNING:** Engine emits toxic gases. Severe respiratory damage or asphyxiation can result. Provide adequate ventilation. Consult with your regulatory authorities for exposure limits. Keep engine properly tuned.

7. Verify that the *1-STEP Scrub* button is off. The light next to the button will be off.

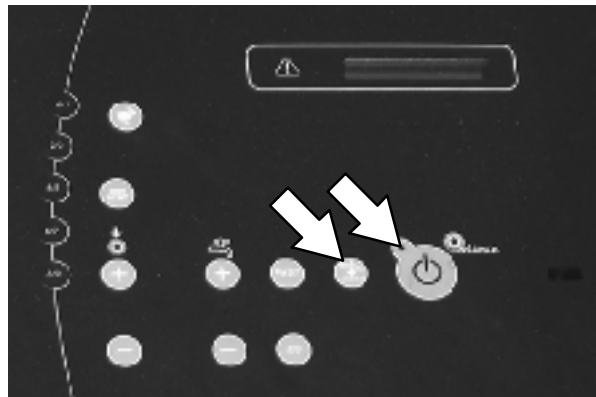

8. Press the *Scrub vacuum fan/squeegee* button. The light above the button will turn on and the vacuum fan will start operating.

*NOTE: The squeegee will also lower.*

## OPERATION

9. Press the top of the *Spray nozzle switch* to turn on the water supply.

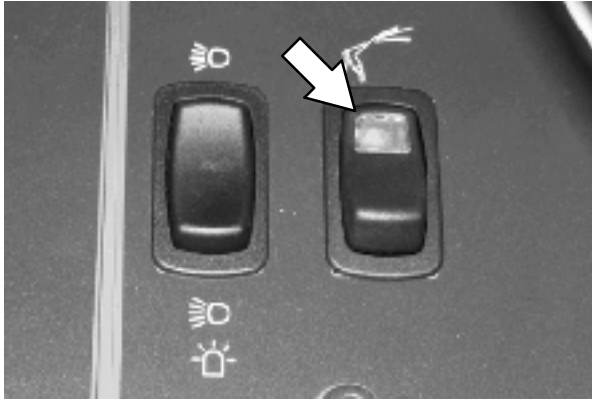

10. Squeeze the solution lever on the power wand to spray solution onto the floor. Scrub the floor with the brush side of the cleaning tool.

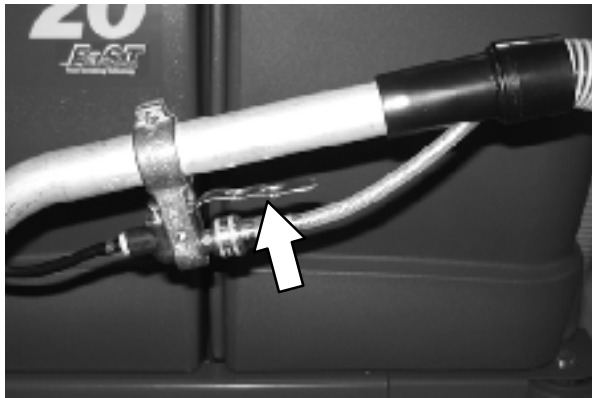

11. Vacuum up the solution by turning over the cleaning tool so the squeegee side is down.



If the cleaning tool is hard to push or is not picking up the solution very well, adjust the roller wheels on the tool by turning the black adjustment knob.

*NOTE: The wheels are properly adjusted when the squeegee blade deflects slightly while the cleaning tool is pushed back and forth.*

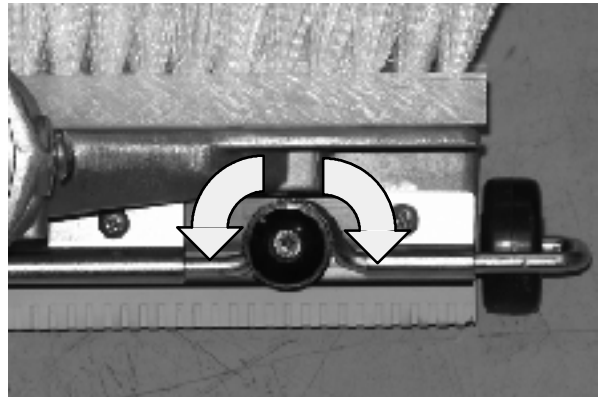

12. When finished scrubbing, press the *Scrub vacuum fan/squeegee button* to turn off the vacuum and press the bottom of the *Spray nozzle switch* to turn off the water supply.

13. Turn off the machine.

14. Disconnect the power wand vacuum hose from the squeegee suction hose and the solution hose from the quick-disconnect fitting.

15. Reconnect the vacuum hose to the rear squeegee assembly.

16. Disassemble the power wand assembly and return it to the storage bag.

**MACHINE TROUBLESHOOTING**

Problem	Cause	Remedy
Trailing water-poor or no water pickup	Scrub vacuum fan turned off	Turn on vacuum fan
	Worn squeegee blades	Rotate or replace squeegee blades
	Squeegee out of adjustment	Adjust squeegee
	No detergent in solution tank causing squeegee to chatter	Add detergent to solution tank
	Vacuum hose clogged	Flush vacuum hoses
	Vacuum screen dirty	Clean vacuum screen
	Recovery tank cover seals worn	Replace seals
	Debris caught in squeegee	Remove debris
	Vacuum hose to squeegee or recovery tank disconnected or damaged	Reconnect or replace vacuum hose
	Recovery tank cover not completely closed	Check for obstructions and make sure cover is closed properly
Scrub vacuum fan will not turn on	Vacuum fan / squeegee button turned off	Turn on Vacuum fan / squeegee button
	Recovery tank full	Drain recovery tank
	Foam filling recovery tank	Empty recovery tank
		Use less detergent/or use defoamer
Recovery tank sensor dirty or stuck	Clean or replace sensor	
Little or no solution flow to the floor (Conventional Scrubbing Mode)	Solution tank empty	Fill solution tank
	Solution flow turned off	Turn on solution flow
	Solution supply lines plugged	Flush solution supply lines
Poor scrubbing performance	<i>1-STEP Scrub button</i> not on	Turn on <i>1-STEP Scrub button</i>
	Improper detergent or brushes	Call Tennant service representative
	Solution tank empty	Fill solution tank
	Debris caught on main brushes	Remove debris
	Worn main brushes	Replace brushes
	Brush pressure set too light	Increase brush pressure

## OPERATION

Problem	Cause	Remedy
FaST System does not operate	FaST button is turned off	Turn on the FaST button
	Clogged FaST-PAK supply hose and/or connector	Soak connector and hose in warm water and clean
	FaST-PAK carton is empty or not connected	Replace FaST-PAK carton and/or connect supply hose
	FaST system is not primed	To prime, operate the FaST solution system for a few minutes
	Clogged filter screen	Drain solution tank, remove and clean filter screen
	Blown fuse	Call Tennant service representative
	Faulty solution pump	Call Tennant service representative
ES System does not operate	<i>ES button</i> is turned off	Turn on <i>ES button</i>
	ES sensor in tank dirty	Clean sensor
	Clogged ES pump filter	Clean ES filter
	Water level in recovery tank too low	Fill recovery tank about half full
	Water level in solution tank too low	Fill solution tank

MAINTENANCE

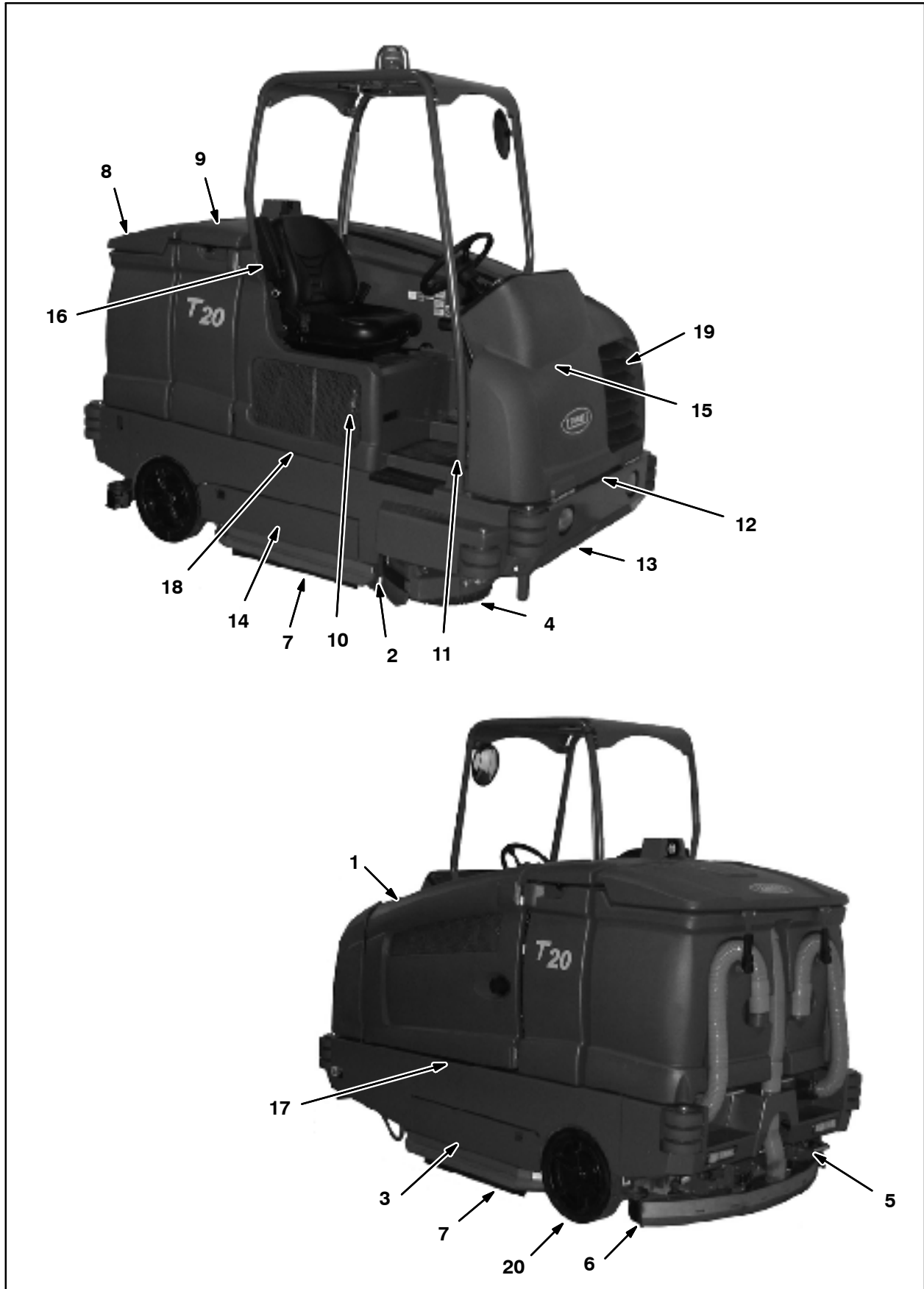

# MAINTENANCE

## MAINTENANCE CHART

Interval	Key	Description	Procedure	Lubricant/ Fluid	No. of Service Points
Daily	1	Engine	Check oil level	EO	1
			Check coolant level in reservoir	WG	1
			Check belt tension	-	1
	10	Hydraulic fluid reservoir	Check fluid level	HYDO	1
	8, 9	Tank cover seals	Check for damage or wear	-	3
	3, 14	Main brushes (Cylindrical)	Check for damage and wear	-	2
	3, 14	Main brushes or pads (Disk)	Check for damage and wear	-	3
	4	Side brush (option)	Check for damage and wear	-	1
			Check squeegee blade for damage and wear	-	1
	6	Rear squeegee blade	Check for damage and wear	-	1
			Check deflection	-	1
	7	Side squeegee blades	Check for damage and wear	-	2
	8	Recovery tank	Clean	-	1
	8	Recovery tank, ES mode (option)	Clean ES filter	-	1
	9	Solution tank, ES mode (option)	Clean	-	1
5	Debris tray	Clean debris tray, screen, and hose	-	1	
50 Hours	16	FaST filter screen (Option)	Clean	-	1
	3, 14	Main brushes (Cylindrical)	Check brush pattern and rotate front to rear	-	2
	13	Front wheel	Torque wheel nuts <b>(after initial 50 hours only)</b>	-	1
	15	Battery	Clean and tighten battery cable connections <b>(after initial 50 hours only)</b>	-	1
100 Hours	19	Radiator	Clean core exterior	-	1
			Check coolant level	WG	1
	19	Hydraulic cooler	Clean core exterior	-	1
	1	Engine	Change oil and filter	EO	1
			Drain oil from electronic pressure regulator (EPR) (machines serial number 001500 and above)	-	1
	13, 20	Tires	Check for damage	-	3
	6	Rear squeegee casters	Lubricate	SPL	2
	6	Rear squeegee	Check leveling	-	1
	2	Scrub head skirt	Check for damage or wear	-	1
3, 14	Disk scrub head stop bumper	Check for damage or wear	-	2	

Interval	Key	Description	Procedure	Lubricant/ Fluid	No. of Service Points
200 Hours	12	Front wheel support bearings	Lubricate	SPL	2
	17, 18	Torque tube (Cylindrical brushes)	Lubricate	SPL	4
	3, 14	Torque tube (Disk brushes)	Lubricate	SPL	4
	3	Pivot shaft (Disk brushes)	Lubricate	SPL	4
	12	Steering cylinder	Lubricate	SPL	1
	1, 19	Radiator hoses and clamps	Check for tightness and wear	-	2
	11	Parking brake	Check adjustment	-	1
	11	Brake pedal	Check adjustment	-	1
	16	FaST air filter (Option) (S/N 000000-001742)	Clean	-	1
400 Hours	1	Engine	Clean and re-gap or replace spark plugs	-	4
			Replace air filter	-	1
			Replace fuel filter	-	1
800 Hours	10	Hydraulic reservoir	Change hydraulic fluid	HYDO	1
			Replace strainer outlet		1
			Replace filler cap		1
			Replace fluid filter	-	1
	1	Engine	Check timing belt	-	1
	-	Hydraulic hoses	Check for wear and damage	-	All
	1, 19	Cooling system	Flush	WG	2
	13	Propelling motor	Torque shaft nut	-	1
	13	Front wheel	Torque wheel nuts	-	1
	15	Battery	Clean and tighten battery cable connections	-	1
1000 Hours	16	FaST system filters (S/N 001743- )	Replace	-	2
2000 Hours	1	Engine	Replace timing belt	-	1

**LUBRICANT/FLUID**

EO . . . Engine oil, 10W30 SAE-SG/SH only.

HYDO . Tennant or approved hydraulic fluid

WG . . . Water and ethylene glycol anti-freeze, -34° C (-30° F)

SPL . . . Special lubricant, Lubriplate EMB grease (Tennant part number 01433-1)

*NOTE: More frequent maintenance intervals may be required in extremely dusty conditions.*

# MAINTENANCE

## LUBRICATION

### ENGINE OIL

Check the engine oil level daily. Change the oil and oil filter after every 100 hours of operation.

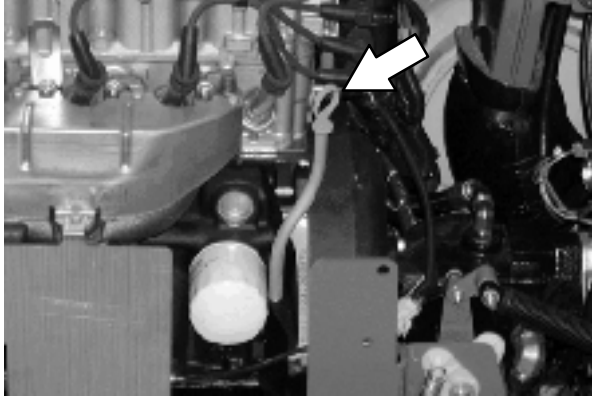

Fill the engine with oil until the oil is between the indicator marks on the dipstick. DO NOT fill past the top indicator mark. The engine oil capacity is 3.5 L (3.7 qt) with oil filter.

### SQUEEGEE CASTER BEARINGS

Lubricate the squeegee caster bearings after every 100 hours of operation.

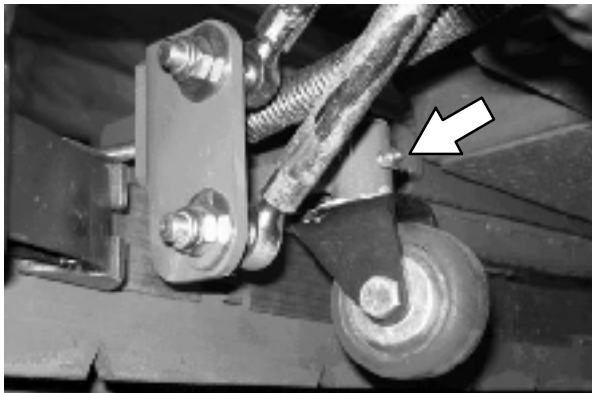

### FRONT WHEEL SUPPORT BEARING

Lubricate the front wheel support bearings after every 200 hours of operation. Both front wheel support grease fittings are located underneath the frame support plate.

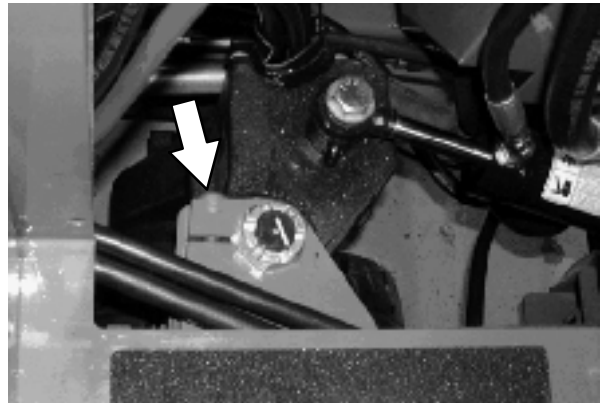

### STEERING CYLINDER BEARING

Lubricate the steering cylinder after every 200 hours of operation. The steering cylinder bearing is located next to the front wheel support.

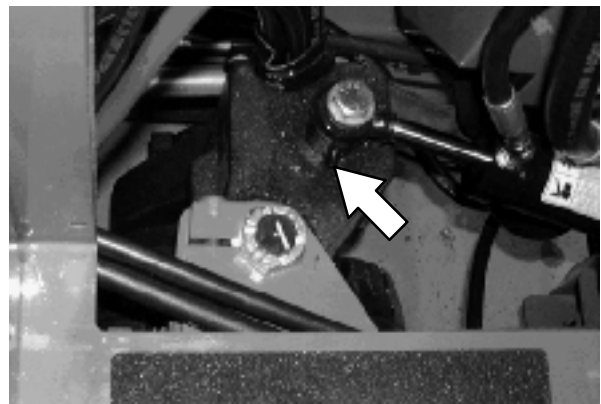



**TORQUE TUBES-CYLINDRICAL BRUSHES**

Lubricate the torque tubes after every 200 hours of operation. The torque tube grease fittings on the operator side of the machine are located beneath the fuel tank.

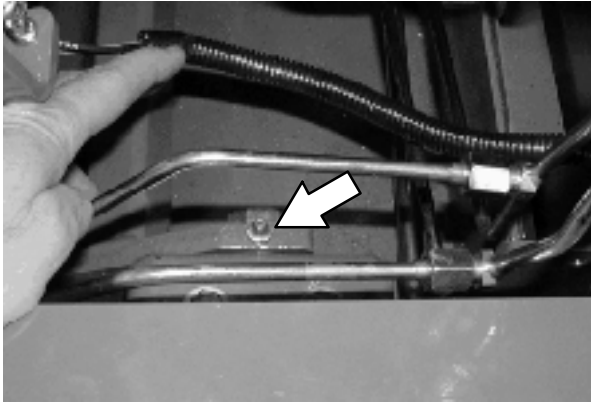

On the other side of the machine the torque tube grease fittings are located beneath the propel pump.

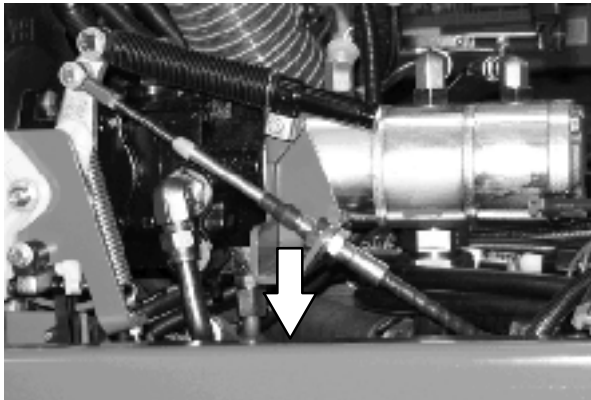
**TORQUE TUBES-DISK BRUSHES**

Lubricate the three torque tube fittings after every 200 hours of operation. The first two fittings are located on each side of the machine and the third is located above the center brush.

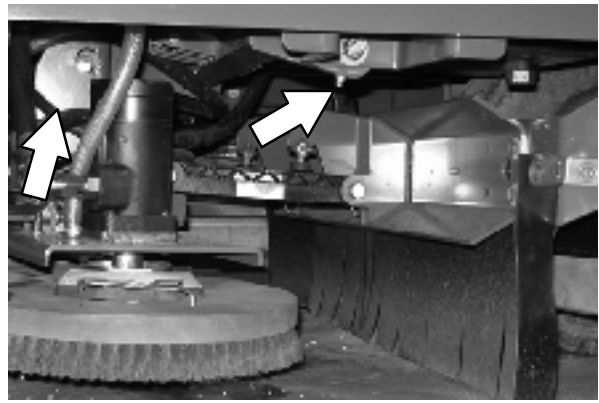
**PIVOT SHAFT-DISK BRUSHES**

Lubricate the pivot shaft after every 200 hours of operation.

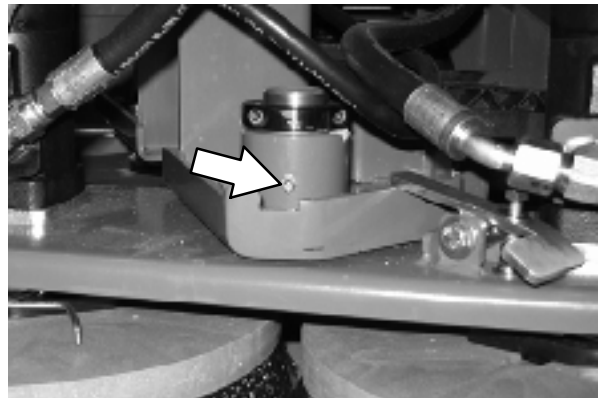

## HYDRAULICS

Check the hydraulic fluid level at operating temperature daily. The hydraulic fluid level should be between the two lines on the hydraulic gauge.

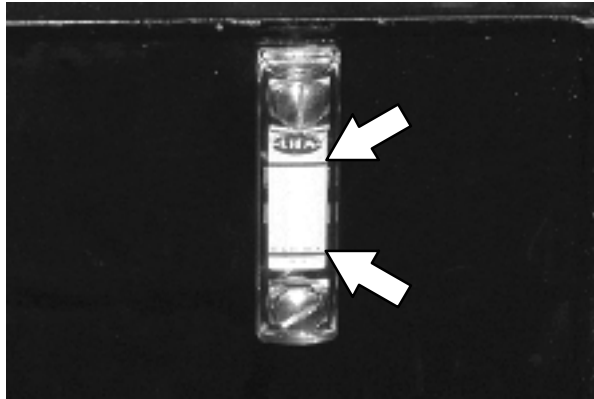

**ATTENTION! Do not overfill the hydraulic fluid reservoir or operate the machine with a low level of hydraulic fluid in the reservoir. Damage to the machine hydraulic system may result.**

Drain and refill the hydraulic fluid reservoir with new hydraulic fluid after every 800 hours of operation.

Replace the filler cap after every 800 hours of operation. Apply a light film of hydraulic fluid onto the filler cap gasket before installing the cap onto the reservoir.

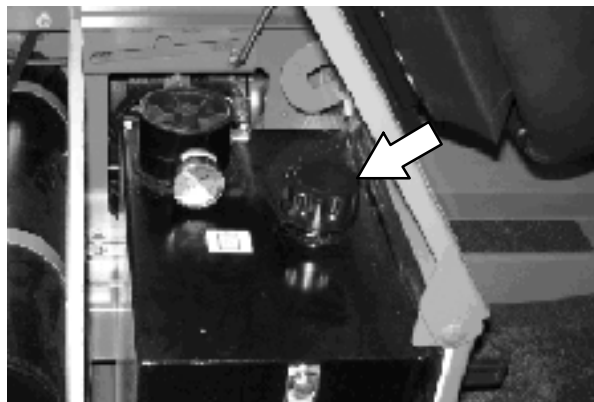

Replace the hydraulic fluid filter after every 800 hours of operation or if the hydraulic reservoir gauge is in the yellow/red zone when the reservoir hydraulic fluid is approximately 32°C (90° F).

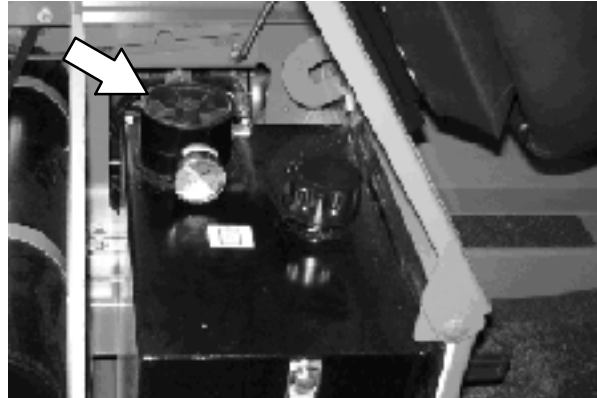

Replace the hydraulic strainer outlet after every 800 hours of operation.

## HYDRAULIC FLUID

Tennant hydraulic fluid is specially selected to meet the needs of Tennant machines. There are two fluids available for different temperature ranges:

Tennant part no.	Ambient Temperature
65869	above 7° C (45° F)
65870	below 7° C (45° F)

High temperature fluids have a higher viscosity (thicker) and should only be used in high temperature environments. Low temperature fluids have a lower viscosity (thinner) and should only be used in cold temperature environments. Select the appropriate hydraulic fluid for the environment where the machine is operated. Using improper hydraulic fluids can cause premature failure of hydraulic components.

If using a locally-available hydraulic fluid, be sure the specifications match Tennant hydraulic fluid specifications. Substitute fluids can cause premature failure of hydraulic components.

**ATTENTION! Hydraulic components depend on system hydraulic fluid for internal lubrication. Malfunctions, accelerated wear, and damage will result if dirt or other contaminants enter the hydraulic system.**

**HYDRAULIC HOSES**

Check the hydraulic hoses after every 800 hours of operation for wear or damage.

**FOR SAFETY: When servicing machine, use cardboard to locate leaking hydraulic fluid under pressure.**

High pressure fluid escaping from a very small hole can almost be invisible, and can cause serious injuries.

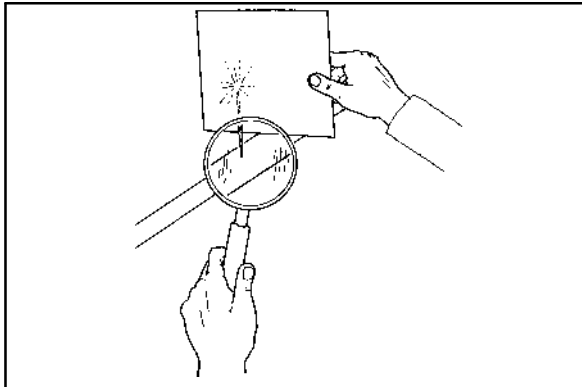

00002

Consult a physician immediately if injury results from escaping hydraulic fluid. Serious infection or reaction can occur if proper medical treatment is not given immediately.

Contact a mechanic or supervisor if a leak is discovered.

**ENGINE****COOLING SYSTEM**

**FOR SAFETY: When servicing machine, avoid contact with hot engine coolant.**

Check the coolant level in the reservoir daily. The coolant level must be between the indicator marks when the engine is cold.

**FOR SAFETY: When servicing machine, do not remove cap from radiator when engine is hot. Allow engine to cool.**

Check the coolant level in the radiator after every 100 hours of operation. Refer to the coolant manufacture for water/coolant mixing instructions.



Flush the radiator and the cooling system after every 800 hours of operation.

## MAINTENANCE

The cooling system must be completely filled with coolant to keep the engine from overheating. When filling the cooling system, open the drain cocks to bleed the air from the system.

Location of drain cock on LPG machines.

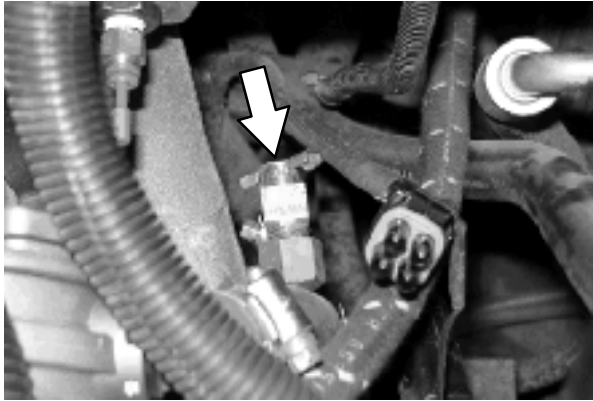

Location of drain cock on gasoline machines. Remove the panel from operators compartment to access the drain cock.

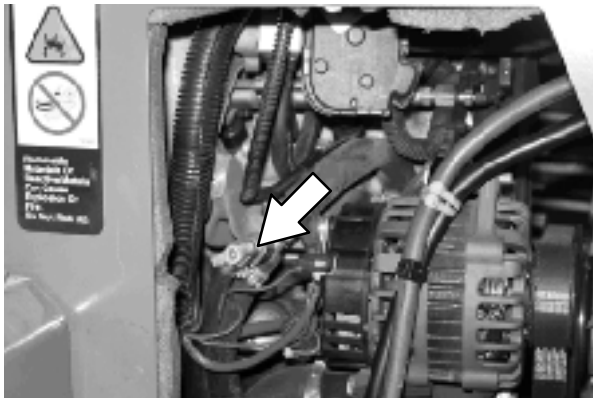

Check the radiator hoses and clamps after every 200 hours of operation. Tighten loose clamps. Replace damaged hoses and clamps.

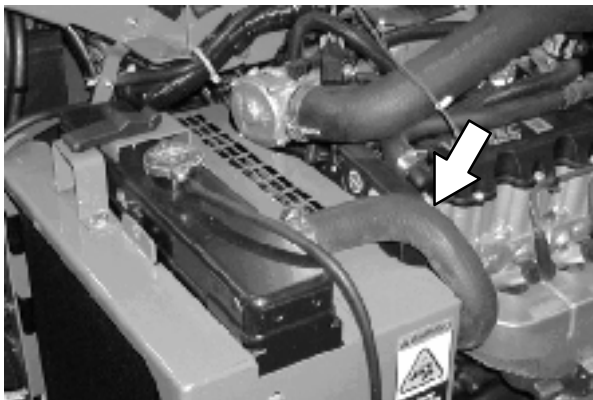

Check the radiator core exterior and hydraulic cooler fins for debris after every 100 hours of operation. Blow or rinse all dust through the grille and radiator fins, in the opposite direction of normal air flow. Be careful to not bend the cooling fins when cleaning. Clean thoroughly to prevent the fins from becoming encrusted with dust. To avoid cracking the radiator, allow the radiator and cooler fins to cool before cleaning.

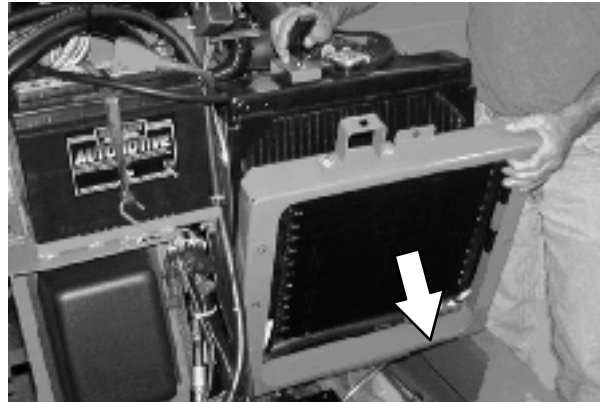

**FOR SAFETY: When servicing machine, wear eye and ear protection when using pressurized air or water.**

### AIR FILTER

Replace the air filter after every 400 hours of operation.

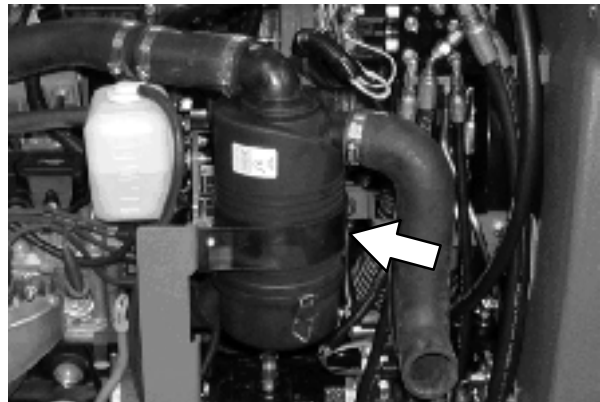

## FUEL FILTER (LPG)

Replace the LPG fuel filter after every 400 hours of operation.

**FOR SAFETY: When servicing machine, keep flames and sparks away from fuel system service area. Keep area well ventilated.**

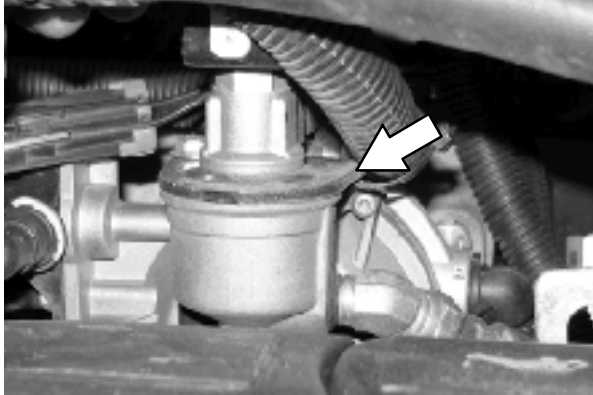

Disassemble the fuel lock off valve to access the LPG fuel filter.



## ELECTRONIC PRESSURE REGULATOR (LPG) (For machines serial number 001500 and above)

Remove the sensor and drain the oil from the LPG electronic pressure regulator after every 100 hours of operation.

**FOR SAFETY: When servicing machine, keep flames and sparks away from fuel system service area. Keep area well ventilated.**



## FUEL FILTER (Gasoline)

Replace the gasoline fuel filter after every 400 hours of operation.

**FOR SAFETY: When servicing machine, keep flames and sparks away from fuel system service area. Keep area well ventilated.**

Location of fuel filter on machines serial number 001499 and below.

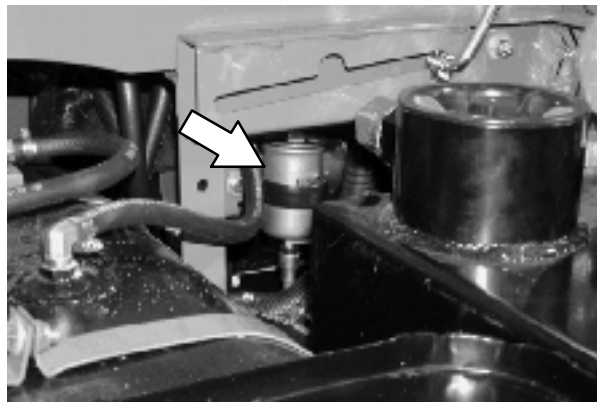

## MAINTENANCE

Location of fuel filter on machines serial number 001500 and above.



### ENGINE BELT

Check the belt tension daily. Adjust tension as necessary. Proper belt tension is 13 mm (0.50 in) from a force of 4 to 5 kg (8 to 10 lb) applied at the mid-point of the longest span.

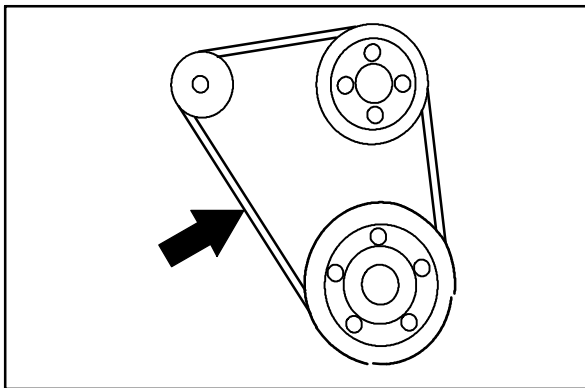

**WARNING:** Moving belt and fan. Keep away.

### SPARK PLUGS

Clean or replace, and set the gap of the spark plugs after every 400 hours of operation. The proper spark plug gap is 1 mm (0.042 in).

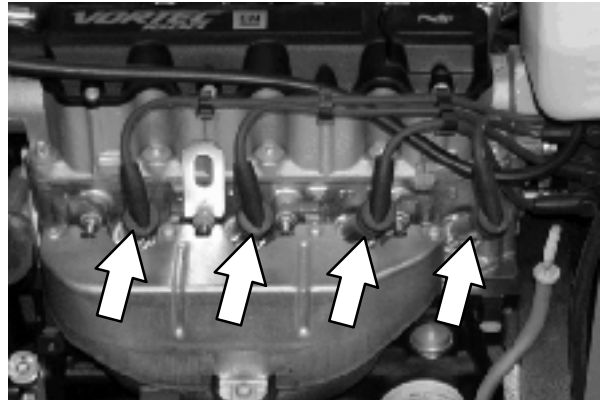

### TIMING BELT

Check the timing belt after every 800 hours of operation.

Replace the timing belt after every 2000 hours of operation.

---

### BATTERY

---

Clean and tighten the battery connections after the first 50 hours of operation and after every 800 hours after that. Do not remove the vent plugs from the battery or add water to the battery.



**FOR SAFETY:** When servicing machine, avoid contact with battery acid.

**FUSES AND RELAYS**

**RELAY PANEL FUSES AND RELAYS**

*Fuses* are one-time protection devices designed to protect the wire harness by stopping the flow of current in the event of a circuit overload. *Relays* switch the electrical power going to the machine electrical systems on/off. Remove the relay panel cover to access *fuses* and *relays*.

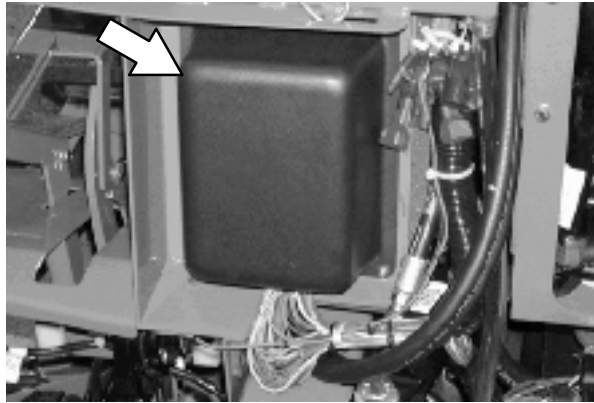

**NOTE:** Always replace a fuse with a fuse of the same amperage. Extra 15 Amp fuses are provided inside the relay panel drawer on the relay panel.

Refer to the diagram below for locations of the *fuses* and *relays* on the relay panel. The M10 relay for the optional spray nozzle is located behind the battery.

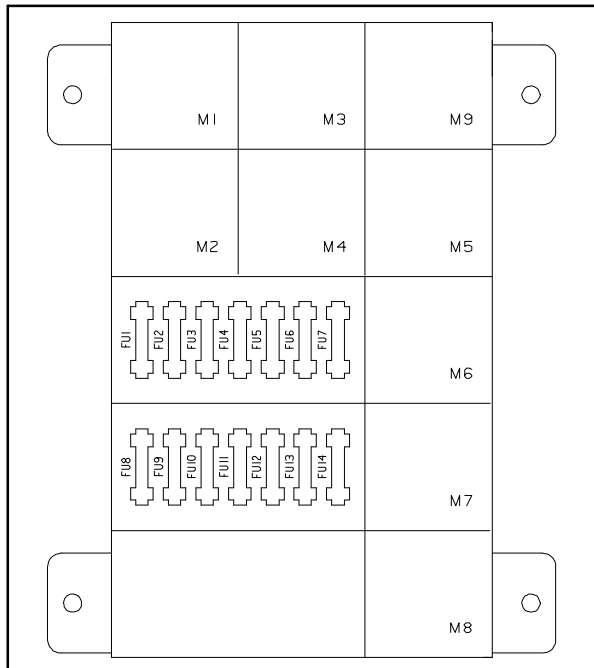

Refer to the table below for the *fuses* and circuits protected.

Fuse	Rating	Circuit Protected
FU1	15 A	Auxiliary Relays/Engine Controls
FU2	15 A	Not Used
FU3	15 A	Horn
FU4	15 A	Not Used
FU5	15 A	Scrub Vacuum/Main Brush/Squeegee Down
FU6	15 A	Enable/Side Brush
FU7	15 A	Solution/Auto Fill/Reverse
FU8	15 A	ES/FaST/Detergent/Spray Wand
FU9	15 A	Lights
FU10	15 A	Unswitched B+ for controller board
FU11	15 A	Not Used: Options
FU12	15 A	Spray Nozzle Pump
FU13	15 A	Not Used
FU14	15 A	Not Used

Refer to the table below for the *relays* and circuits controlled.

Relay	Rating	Circuit Controlled
M1	12 VDC, 40 A	Auxiliary 1
M2	12 VDC, 40 A	Auxiliary 2
M3	12 VDC, 40 A	Not Used
M4	12 VDC, 40 A	Reverse
M5	12 VDC, 40 A	Horn
M6	12 VDC, 40 A	Shutdown
M7	12 VDC, 40 A	Starter
M8	12 VDC, 40 A	Not Used
M9	12 VDC, 40 A	Not Used
M10	12 VDC, 40 A	Not Used
M11	12 VDC, 40 A	FaST Water Pump (located in FaST harness)
M12	12 VDC, 40 A	Spray Wand (located in Spray wand harness)

## MAINTENANCE

### ENGINE HARNESS FUSES AND RELAYS

The *engine harness fuses and relays* are located in the fuse box on the side panel inside the engine compartment. Refer to the fuse box cover for locations of engine harness fuses and relays.

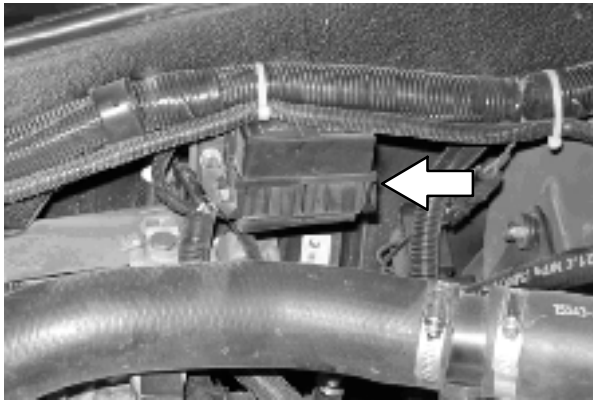

**NOTE:** Always replace a fuse with a fuse of the same amperage.

---

### SCRUB BRUSHES AND PADS

---

The machine can be equipped with either *disk* or *cylindrical* scrub brushes, or cleaning pads. Check scrub brushes or pads daily for wire or string tangled around the brush or brush drive hub. Also check brushes or pads for damage and wear.

#### DISK BRUSHES

Replace the brushes when they no longer clean effectively..

Cleaning pads must be placed on pad drivers before they are ready to use. The cleaning pad is held in place the center disk.

Cleaning pads need to be cleaned immediately after use with soap and water. Do not wash the pads with a pressure washer. Hang pads, or lay pads flat to dry.

**NOTE:** Always replace brushes and pads in sets. Otherwise one brush or pad will be more aggressive than the other.

### REPLACING DISK BRUSHES OR PAD DRIVER

1. Raise the scrub head.

**FOR SAFETY:** Before leaving or servicing machine, stop on level surface, set parking brake, and turn off machine.

2. Open the right outer brush door.

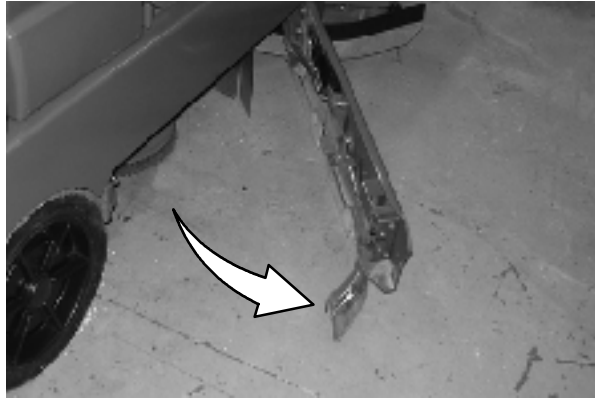

3. Hold down the release lever and rotate the adjustable disk brush head until it is possible to access the center brush.

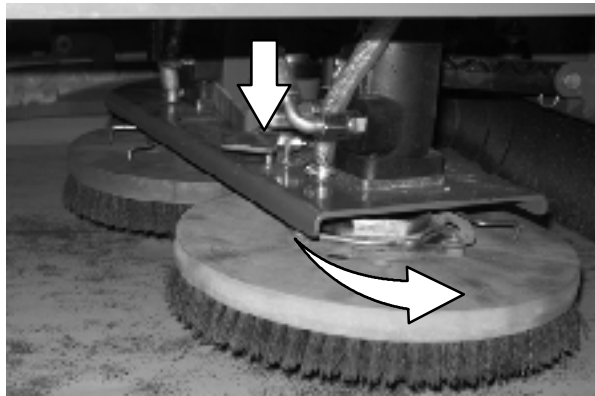



4. Turn the brushes until the spring handles are visible.
5. Squeeze the spring handles and let the brushes drop to the floor.



6. Remove the brushes from underneath the scrub head.
7. Place the new brushes underneath the scrub head and lift each brush up onto the hub until the brush locks onto the hub.
8. Rotate the disk brush head back to the scrub position until the head locks into place.

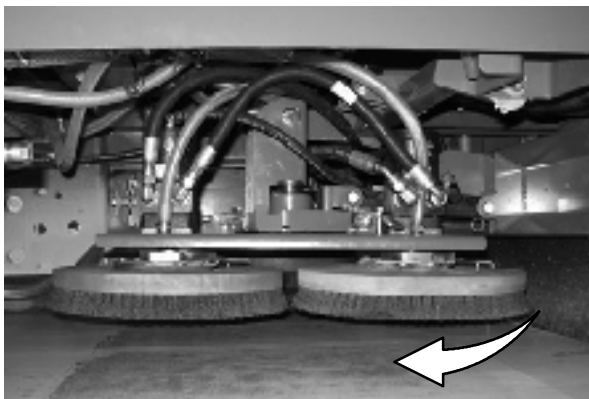

9. Close the right outer brush door.
10. Open the left outer brush door and repeat the procedure for the left brush.

*NOTE: The center brush can only be accessed from the right side of the machine.*

## REPLACING DISK PADS

1. Remove the pad driver from the machine.
2. Squeeze the spring clip together to remove the center disk.

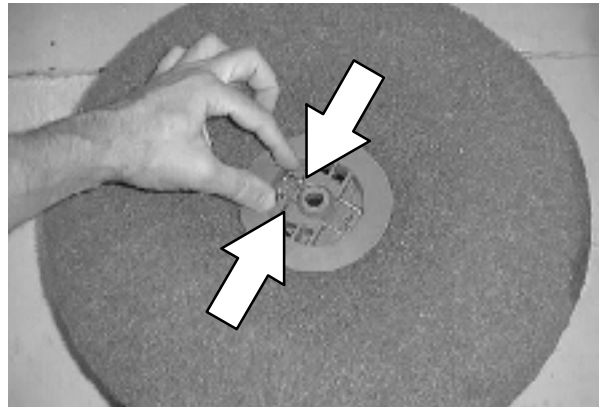

3. Flip or replace the scrub pad, center the scrub pad on the pad driver. Then reinstall the center disk to secure the pad in place on the pad driver.

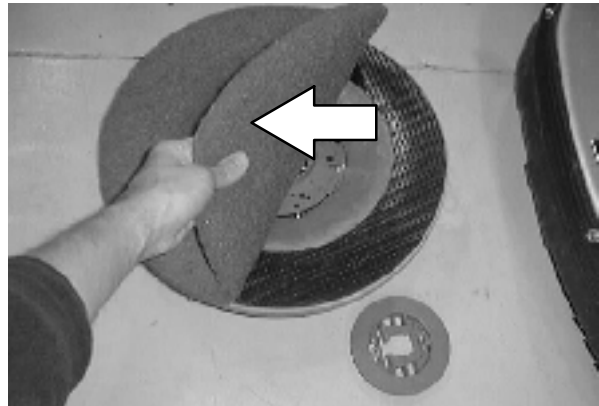

4. Reinsert the pad driver into the machine.

## MAINTENANCE

### CHECKING THE DISK SCRUB HEAD STOP BUMPERS

The disk scrub head stop bumpers keep the scrub head parallel with the floor when in the raised position. This protects the brushes when transporting. Check the lift stop bumpers after every 100 hours of operation for wear or damage.

1. Raise the scrub head.

**FOR SAFETY: Before leaving or servicing machine, stop on level surface, set parking brake, and turn off machine.**

2. Open the right and left outer brush doors.

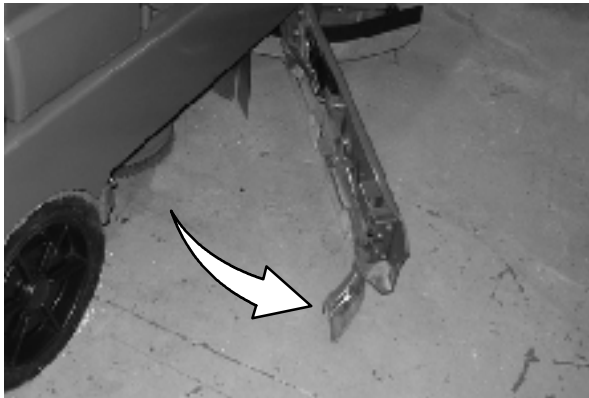

3. Inspect the scrub head stop bumpers. Adjust the bumpers if the scrub head is not parallel with the floor. Replace worn or damaged bumpers.

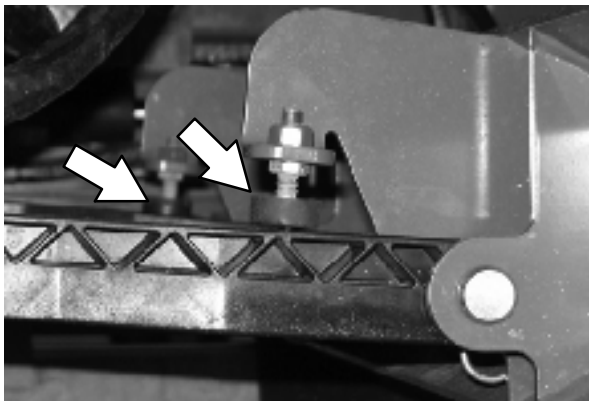

### CYLINDRICAL BRUSHES

Check the brush pattern and rotate the brushes from front-to-rear after every 50 hours of machine operation for maximum brush life and best scrubbing performance.

Replace the brushes when they no longer clean effectively.

*NOTE: Replace worn brushes in pairs. Scrubbing with brushes of unequal bristle length will result in diminished scrubbing performance.*

### REPLACING OR ROTATING CYLINDRICAL BRUSHES

The front brush can be accessed on the left side of the machine and rear brush can be accessed on the right side of the machine.

1. Raise the scrub head.

**FOR SAFETY: Before leaving or servicing machine, stop on level surface, set parking brake, and turn off machine.**

2. Open the outer brush doors.

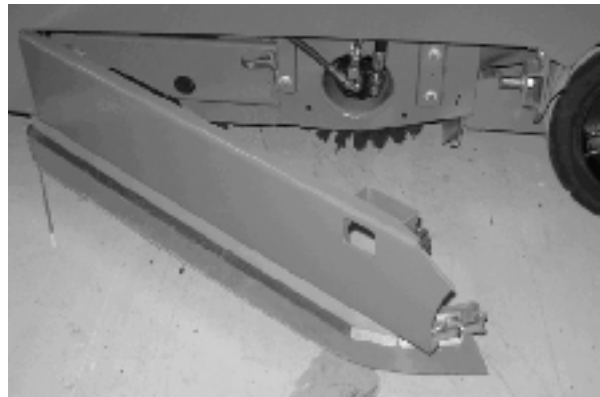

3. Open the inner brush doors.

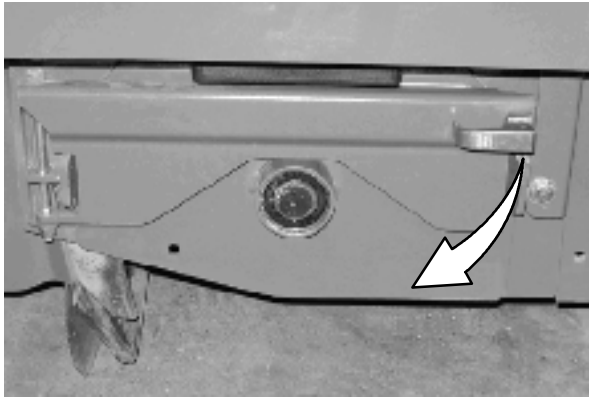

4. Remove the brush idler plates.

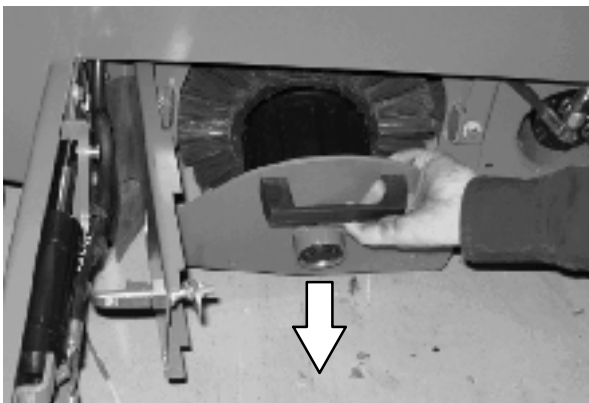

5. Pull the brushes out from the scrub head.

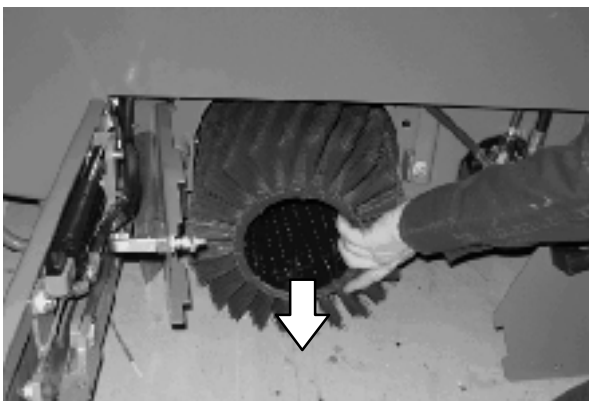

6. Install the new or rotated brushes by pushing down on the ends while sliding them onto the drive motor hubs.

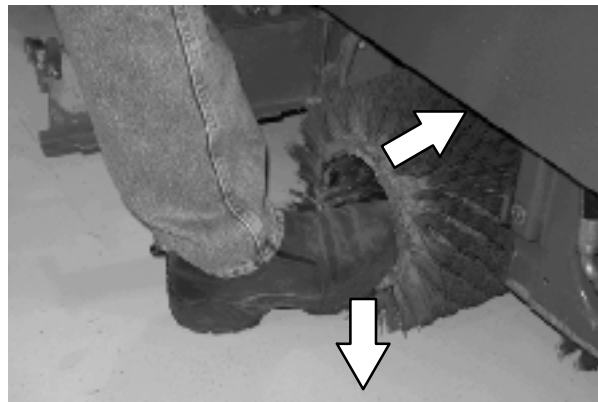

7. If rotating the existing brushes, only rotate front to rear. Do NOT rotate end-for-end.

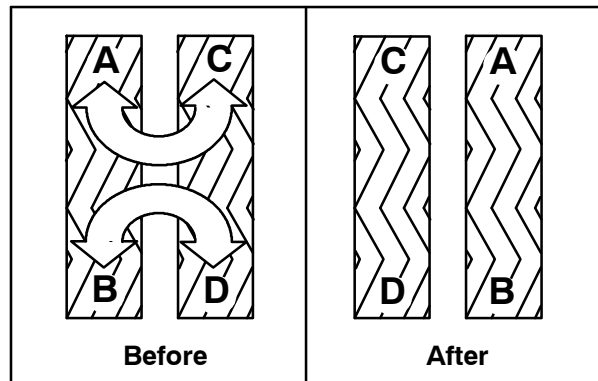

8. Reinstall the brush idler plates.

9. Close the inner and outer brush doors.

10. Check and adjust the brush pattern if needed. Refer to *CHECKING CYLINDRICAL BRUSH PATTERN*.

## MAINTENANCE

### CHECKING CYLINDRICAL BRUSH PATTERN

1. Apply chalk, or a similar marking material, to a smooth and level section of the floor.

*NOTE: If chalk or other material is not available, allow the brush to spin on the floor for two minutes. A polish mark will remain on the floor.*

2. Raise the scrub head, then position the brushes over the chalked area.
3. Set the parking brake.
4. Press the *1-STEP Scrub* button to lower the scrub head. Set the brush pressure to the lowest setting and allow the brushes to operate for 15 to 20 seconds. Keep the scrub head in one spot in the chalked area.
5. Raise the scrub head, release the parking brake, and drive the machine away from the chalked area.

**FOR SAFETY: Before leaving or servicing machine, stop on level surface, set parking brake, and turn off machine.**

6. Observe the brush patterns. If the brush pattern is the same width across the entire length of each brush and both brushes are the same width, no adjustment is necessary.

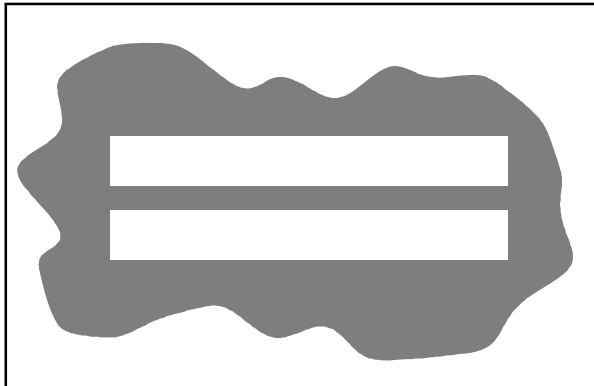

10355

7. If the brush patterns are tapered, see *ADJUSTING THE CYLINDRICAL BRUSH TAPER* section of this manual.

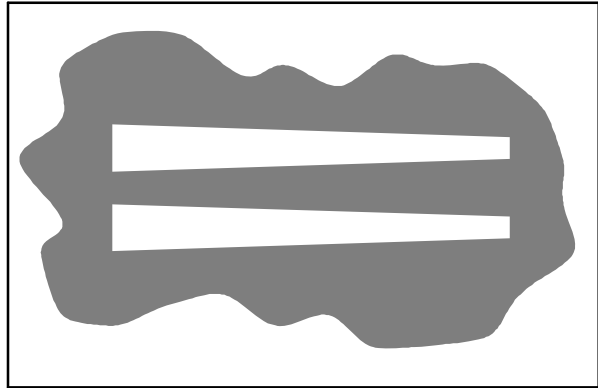

10652

8. The brush patterns should be 75 to 130 mm (3 to 5 in) wide with the brushes in the lowered position and both patterns should be the same width. If the width of the brushes is not the same, see *ADJUSTING THE CYLINDRICAL BRUSH WIDTH* section of this manual.

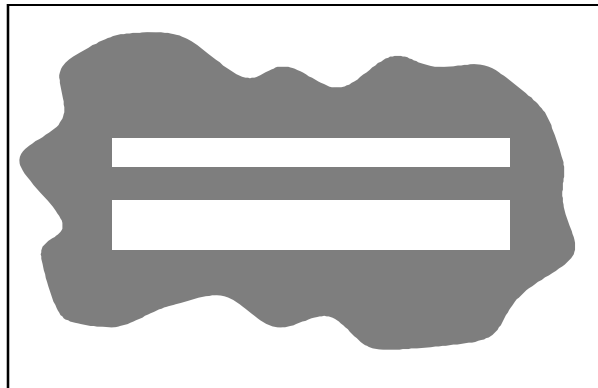

10653

**ADJUSTING THE CYLINDRICAL BRUSH TAPER**

1. Loosen the four mounting bolts on the brush drive housing.

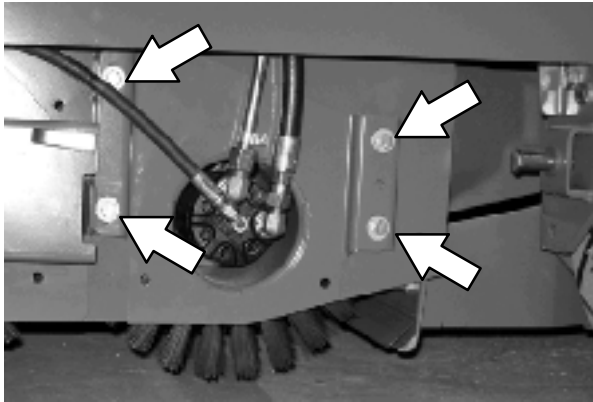

2. Move the brush drive housing up to decrease the pattern width on that side of the scrub head or down to increase the pattern width on that side of the scrub head.
3. Tighten the mounting bolts.
4. Recheck the pattern. Readjust if necessary.

**ADJUSTING THE CYLINDRICAL BRUSH WIDTH**

1. Adjust the length of the drag links on both sides of the scrub head. Lengthen the drag links to increase the rear brush pattern width. Shorten the drag links to increase the front brush pattern. Always adjust the nut on each drag link an equal number of turns.

*NOTE: Two full turns of the drag link adjustment bolt will change the brush pattern approximately 25 mm (1 in).*

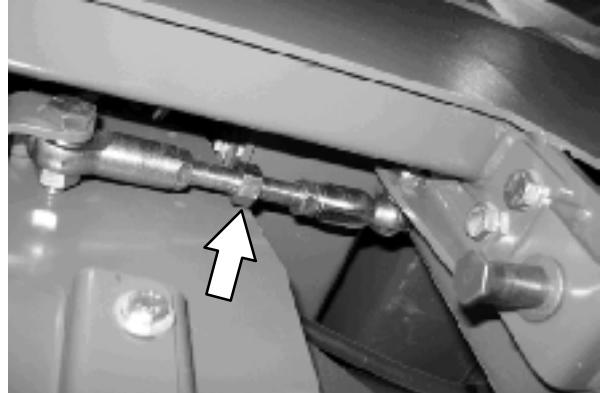

2. Recheck the pattern. Readjust if necessary.

### SIDE BRUSH (OPTION)

---

Check the side brush daily for wear or damage. Remove any tangled string or wire from the side brush or side brush drive hub.

#### REPLACING THE SIDE BRUSH

Replace the brush when it no longer cleans effectively.

1. If necessary, raise the side brush.

**FOR SAFETY: Before leaving or servicing machine, stop on level surface, set parking brake, and turn off machine.**

2. Turn the brush until the spring handles are visible through the access hole in the side brush assembly.
3. Squeeze the spring handles and let the side brush drop to the floor.

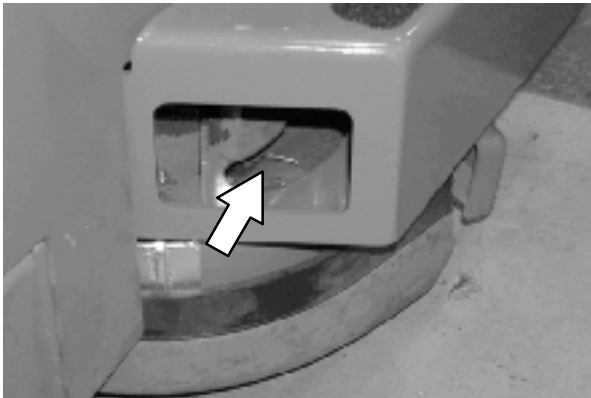

4. Remove the side brush from underneath the side brush assembly.
5. Place the new side brush underneath the side brush assembly and lift the side brush up onto the side brush hub until the brush locks onto the hub.

**FaST SYSTEM****REPLACING THE FaST-PAK CARTON**

**FOR SAFETY: Before leaving or servicing machine, stop on level surface, set parking brake, and turn off machine.**

1. Open the side access door.
2. Slide the seat completely forward.
3. Squeeze the button on the FaST supply hose connector, then pull the empty FaST-PAK carton out from the compartment and discard.

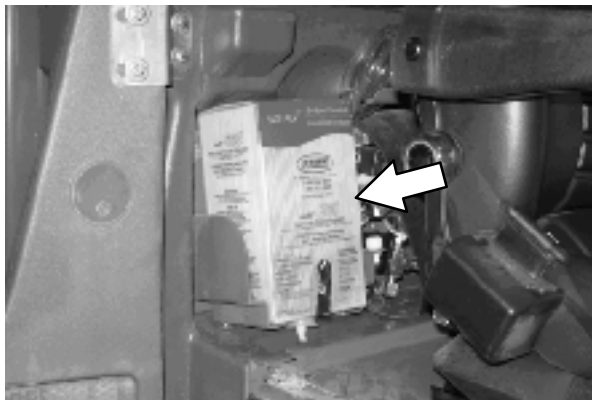

4. Remove the perforated knock outs from the new FaST-PAK carton. Do Not remove the bag from the carton. Pull out the hose connector located on the bottom of the bag and remove the hose cap from the connector.

*NOTE: The FaST-PAK Floor Cleaning Concentrate is specially designed for use with the FaST system scrubbing application. NEVER use a substitute. Other cleaning solutions may cause FaST system failure.*

5. Slide the FaST-PAK carton into the FaST-PAK bracket.
6. Connect the FaST supply hose to the FaST-PAK hose connector.
7. Scrub with the FaST system for a few minutes to allow the detergent to reach maximum foaming.

## MAINTENANCE

### CLEANING THE FaST SUPPLY HOSE CONNECTOR

Soak the connector in warm water if detergent buildup is visible. When a FaST-PAK carton is not installed, store the supply hose connector on the storing plug to prevent the hose from clogging.



### CLEANING THE FaST SYSTEM FILTER SCREEN

The FaST system filter screen filters water from the solution tank as the water flows into the FaST system.

Remove the filter screen bowl and clean the filter screen after every 50 hours of operation. Empty the solution tank before removing the filter.

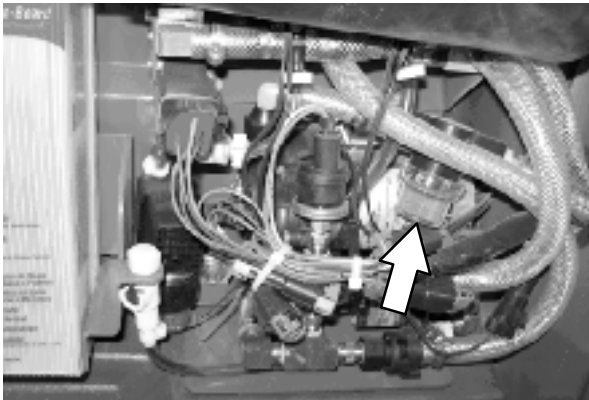

### CLEANING THE FaST SYSTEM AIR PUMP FILTER (S/N 000000 - 001742)

Remove and clean the air filter with compressed air after every 200 hours of FaST scrubbing.

**FOR SAFETY: When servicing machine, wear eye protection when using pressurized air or water.**

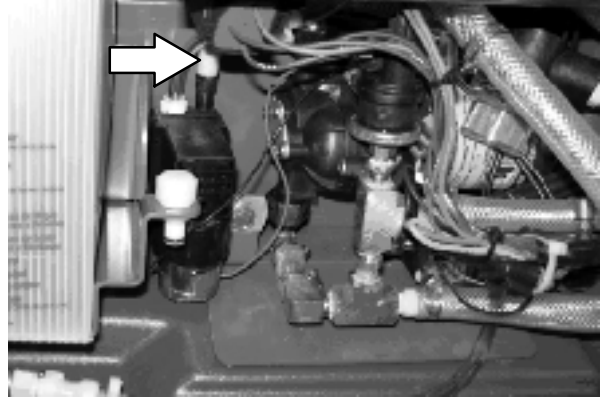

### REPLACING THE FaST SYSTEM FILTERS (S/N 001743- )

Replace the FaST system filters after every 1000 hours of operation. Empty the solution tank before replacing the filters.

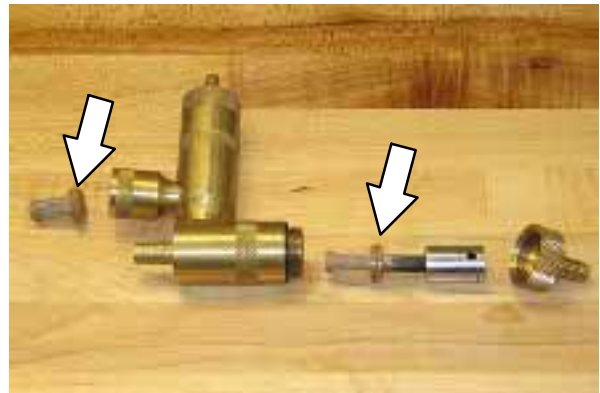
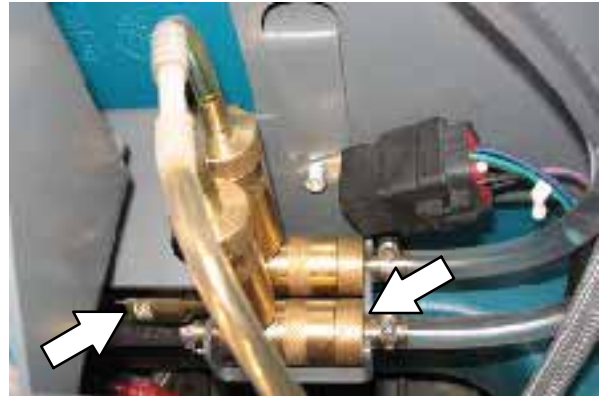



**SQUEEGEE BLADES**

Check the squeegee blades for damage and wear daily. When the blades become worn, rotate the blades end-for-end or top-to-bottom to a new wiping edge. Replace blades when all edges are worn.

Check the deflection of the squeegee blades daily or when scrubbing a different type of surface. Check the leveling of the rear squeegee every 100 hours of operation.

**REPLACING (OR ROTATING) THE REAR SQUEEGEE BLADES**

1. Lower the scrub head.

**FOR SAFETY: Before leaving or servicing machine, stop on level surface, set parking brake, and turn off machine.**

2. Disconnect the vacuum hose from the rear squeegee assembly.

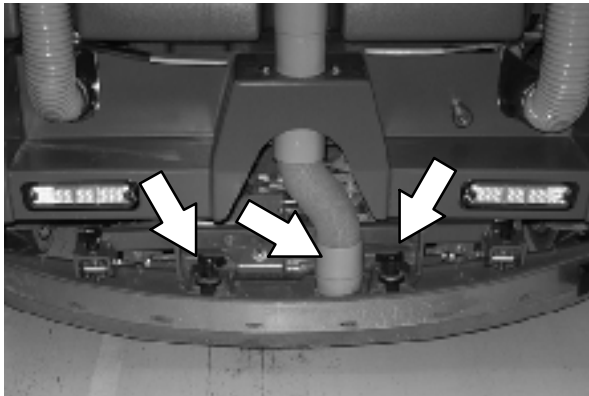

3. Remove both mounting knobs from the rear squeegee assembly.
4. Turn on the machine, raise the scrub head, and turn off the machine.
5. Remove the rear squeegee assembly from the machine.

6. Loosen the rear retaining band tension latch and open the retaining band.

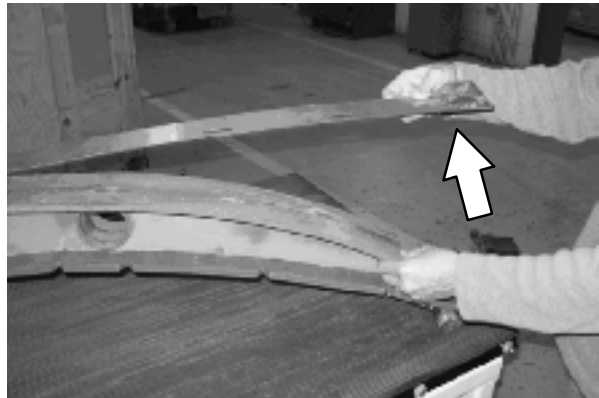

7. Remove the rear squeegee.



## MAINTENANCE

8. Install the new rear squeegee blade or rotate the existing blade to the new edge. Be sure all the holes in the squeegee blade are hooked onto the tabs.



9. Reinstall the rear retaining band aligning the tabs with the holes.



10. Tighten the rear retaining band tension latch.

11. Loosen the front retaining band tension latch and open the retaining band.



12. Remove the front squeegee.



13. Install the new front squeegee blade or rotate the existing blade to the new edge. Be sure the holes in the squeegee blade are hooked onto the tabs.



14. Reinstall the front retaining band aligning the tabs with the notches.

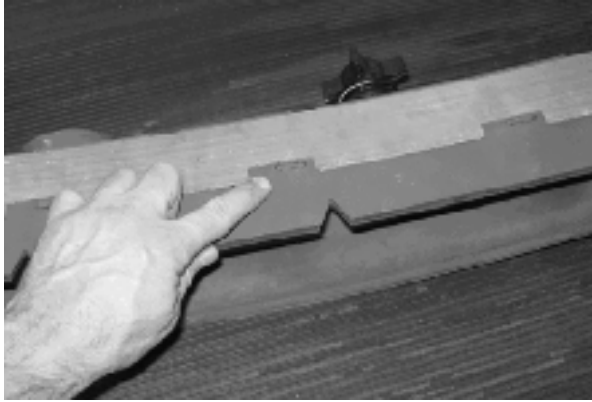

15. Tighten the front retaining band tension latch.
16. Reinstall the rear squeegee assembly onto the machine.
17. Check and adjust the rear squeegee if necessary. Refer to *ADJUSTING THE REAR SQUEEGEE BLADE DEFLECTION* and *LEVELING THE REAR SQUEEGEE* sections of this manual.

### REPLACING OR ROTATING THE SIDE SQUEEGEE BLADES

1. If necessary, raise the scrub head.

**FOR SAFETY: Before leaving or servicing machine, stop on level surface, set parking brake, and turn off machine.**

2. Open the outer brush doors.
3. Unhook the latch on the side squeegee retaining band from the side squeegee assembly.



4. Remove the retaining band from the side squeegee assembly.



## MAINTENANCE

5. Remove the side squeegee blade. If the outer edge of the squeegee blade is not worn, rotate the squeegee blade with the blade from the other side of the machine. Discard the squeegee blade if both edges are worn.



6. Install the new or rotated squeegee blades.



7. Reattach the side squeegee retaining band to the side squeegee assembly.



8. Hook the latch on the side squeegee retaining band.

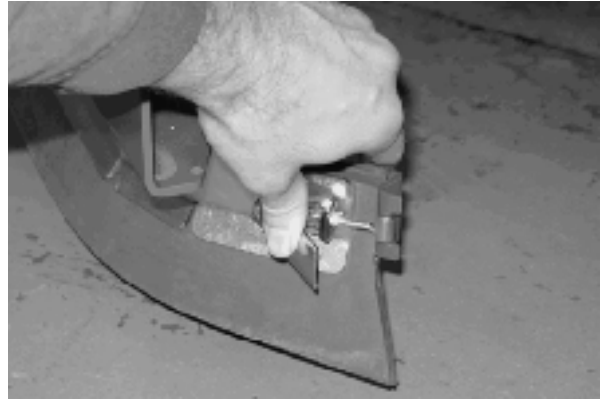

9. Close the outer brush door.

### REPLACING THE SIDE BRUSH SQUEEGEE BLADE (OPTION)

Check the side brush squeegee blade for damage and wear daily. Replace the blade if the leading edge is torn or worn half-way through the thickness of the blade.

1. If necessary, raise the scrub head.

**FOR SAFETY: Before leaving or servicing machine, stop on level surface, set parking brake, and turn off machine.**

2. Pull the pin from the squeegee bumper and open the squeegee bumper.

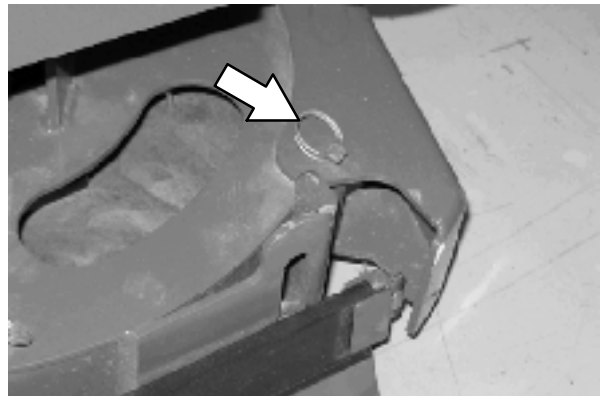

3. Remove the clevis pin and squeegee retainer.

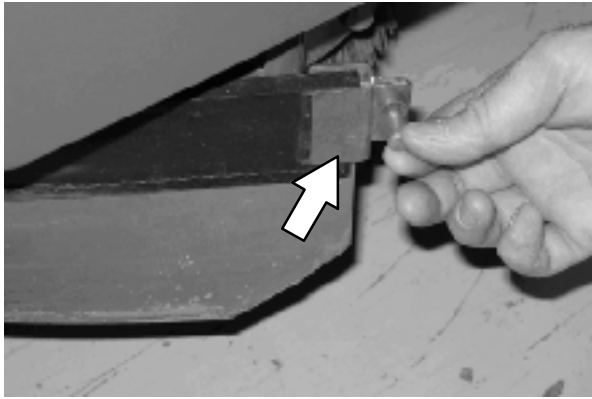

4. Pull the squeegee out from the side brush assembly.

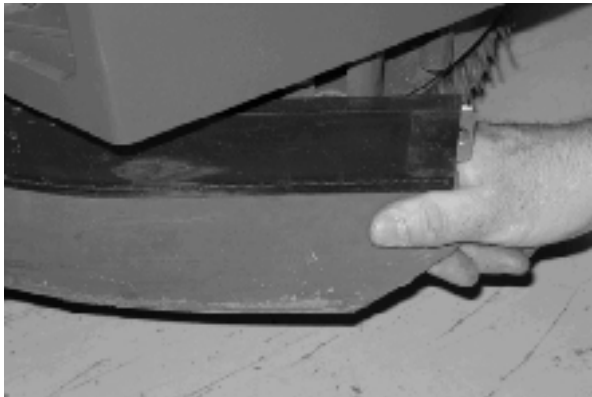

5. Slide the new squeegee into the side brush assembly.
6. Reinstall the squeegee retainer and clevis pin.
7. Close the squeegee bumper and reinsert the pin.

**LEVELING THE REAR SQUEEGEE**

Leveling the squeegee assures the entire length of the squeegee blade is in even contact with the surface being scrubbed. Perform this adjustment on an even and level floor.

1. Lower the squeegee and drive the machine forward a few meters (feet).

**FOR SAFETY: Before leaving or servicing machine, stop on level surface, set parking brake, and turn off machine.**

2. Look at the deflection of the squeegee over the full length of the squeegee blade.
3. If the deflection is not the same over the full length of the blade, turn the squeegee levelling nut to make adjustments.

***DO NOT** disconnect the suction hose from the squeegee frame when leveling squeegee.*

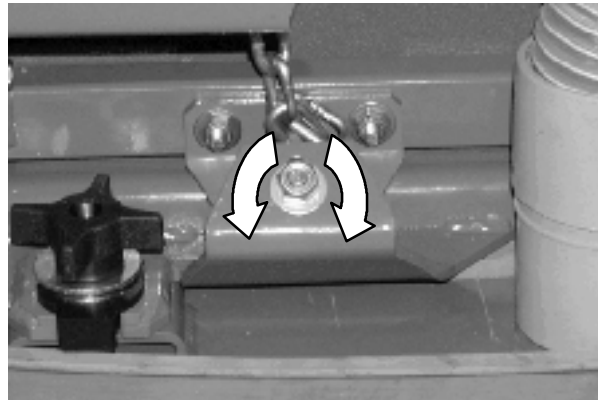

4. Turn the squeegee leveling nut counter-clockwise to decrease the deflection at the ends of the squeegee blade.

Turn the squeegee leveling nut clockwise to increase the deflection at the ends of the squeegee blade.

5. Drive the machine forward with the squeegee down to recheck the squeegee blade deflection if adjustments were made.
6. Readjust the squeegee blade deflection if necessary.

## MAINTENANCE

### ADJUSTING THE REAR SQUEEGEE BLADE DEFLECTION

Deflection is the amount of curl the overall squeegee blade has when the machine moves forward. The best deflection is when the squeegee wipes the floor dry with a minimal amount of deflection.

*NOTE: Make sure the squeegee is level before adjusting the deflection. See LEVELING THE REAR SQUEEGEE.*

1. Lower the squeegee and drive the machine forward a few meters (feet).

**FOR SAFETY: Before leaving or servicing machine, stop on level surface, set parking brake, and turn off machine.**

2. Look at the amount of deflection or “curl” of the squeegee blade. The correct amount of deflection is 12 mm (0.50 in) for scrubbing smooth floors and 15 mm (0.62 in) for rough floors.

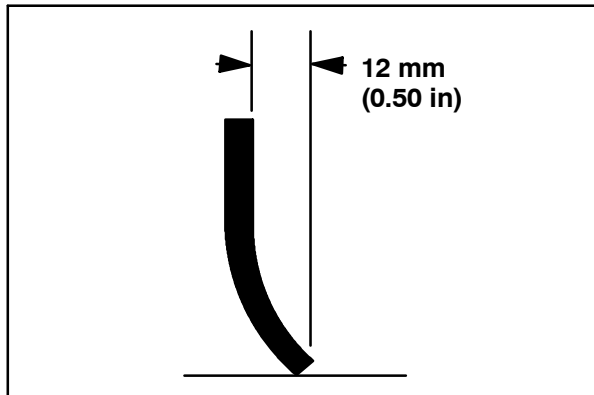

3. To adjust the overall squeegee blade deflection, turn the adjustment knobs counterclockwise to increase deflection or clockwise to decrease deflection.

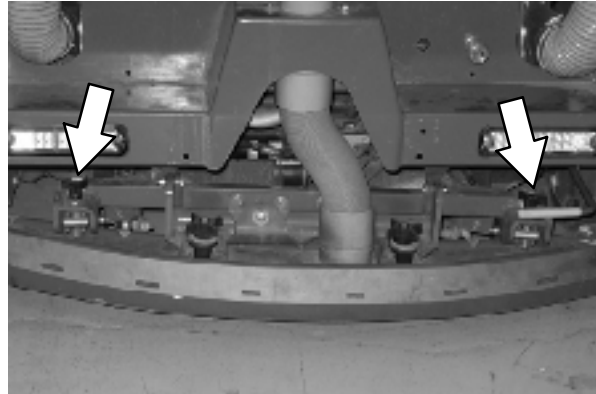

4. Drive the machine forward again to recheck the squeegee blade deflection after adjustments are made.
5. Readjust the squeegee blade deflection if necessary.

---

**SKIRTS AND SEALS**

---

**SCRUB HEAD SKIRT**

Check the skirt for damage and wear after every 100 hours of operation.

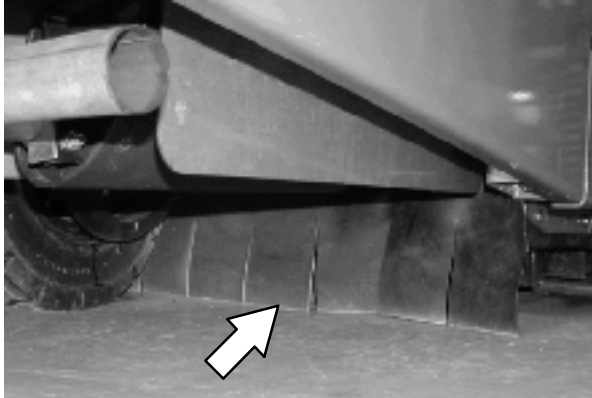

The skirts should be between 0 to 6 mm (0 to 0.25 in) from the floor when the scrub head is down.

**RECOVERY TANK SEAL**

Check the recovery tank cover seal for damage and wear daily.

**SOLUTION TANK SEALS**

Check each solution tank cover seal for damage and wear daily.



## BRAKES AND TIRES

### BRAKES

The mechanical brakes are located on the rear wheels. The brakes are operated by the foot brake pedal and connecting cables.

Check the brake adjustment after every 200 hours of operation.

### PARKING BRAKE

The parking brake is set with the parking brake pedal that activates the brakes.

Check the parking brake adjustment after every 200 hours of operation.

### TIRES

Check tires for damage and wear after every 100 hours of operation.

### FRONT WHEEL

Torque the front wheel nuts twice in the pattern shown to 122 to 149 Nm (90 to 110 ft lb) after the first 50 hours of operation, and after every 800 hours there after.

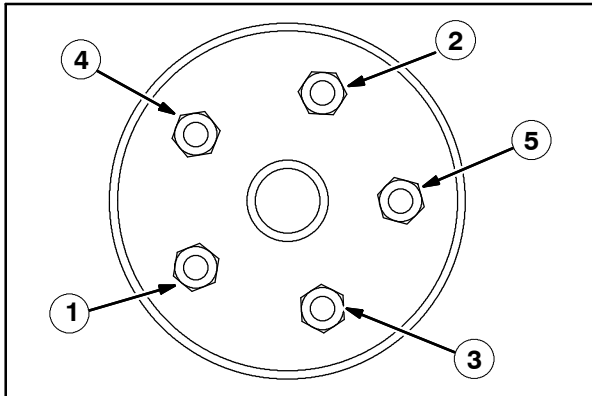

## PROPELLING MOTOR

Torque the shaft nut to 508 Nm (375 ft lb) lubricated, 644 Nm (475 ft lb) dry, after every 800 hours of operation.





**PUSHING, TOWING, AND TRANSPORTING THE MACHINE**

**PUSHING OR TOWING THE MACHINE**

If the machine becomes disabled, it can be pushed from the front or rear, but only towed from the front.

The propelling pump has a bypass valve to prevent damage to the hydraulic system when the machine is being pushed or towed. This valve allows a disabled machine to be moved for a *very short distance* and at a speed to not exceed 1.6 kp/h (1 mph). The machine is NOT intended to be pushed or towed a long distance or at a high speed.

**ATTENTION! Do not push or tow machine for a long distance or damage may occur to the propelling system.**

Turn the bypass valve located on the bottom of the propelling pump 90° (either direction) from the normal position before pushing or towing the machine. Return the bypass valve back to the normal position when through pushing or towing the machine. **Do Not** use the bypass valve during normal machine operation.

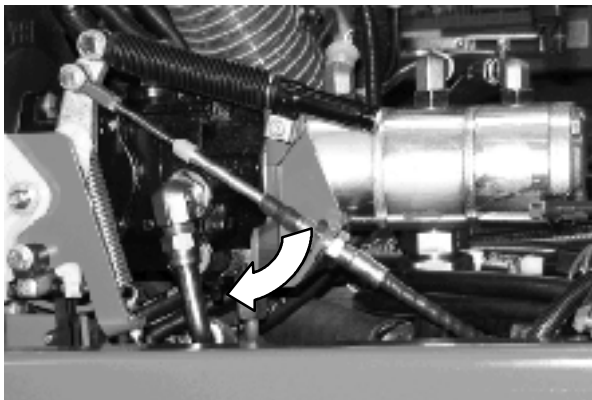
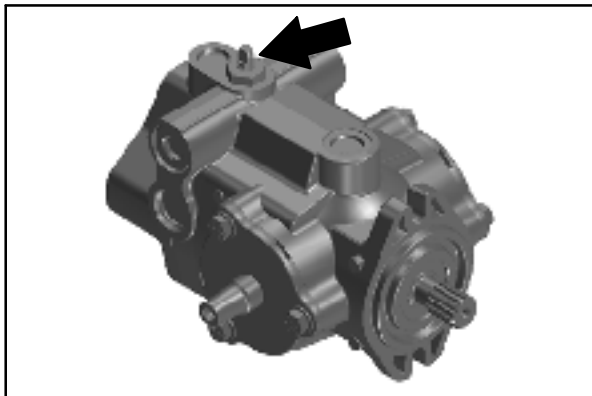

**TRANSPORTING THE MACHINE**

1. Raise the squeegee, scrub head, and brushes.

*NOTE: Empty the debris tray, the recovery tank, and the solution tank before transporting.*

2. Position the rear of the machine at the loading edge of the truck or trailer.
3. If the loading surface is not horizontal or is higher than 380 mm (15 in) from the ground, use a winch to load machine.

If the loading surface is horizontal and 380 mm (15 in) or less from the ground, the machine may be driven onto the truck or trailer.

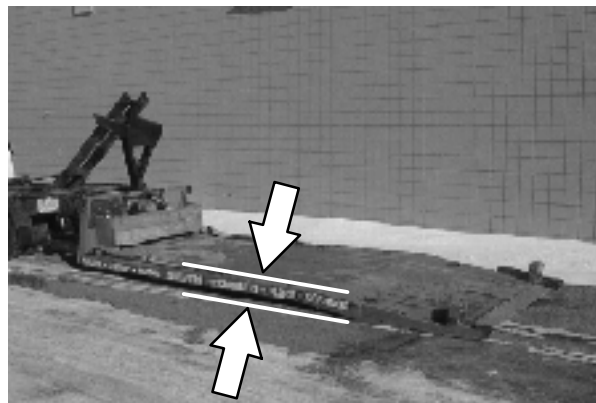

**FOR SAFETY: When loading machine onto truck or trailer, use winch. Do not drive the machine onto the truck or trailer unless the loading surface is horizontal AND is 380 mm (15 in) or less from the ground.**

4. To winch the machine onto the truck or trailer, attach the winching chains to the holes in the rear jacking brackets behind the rear tires.

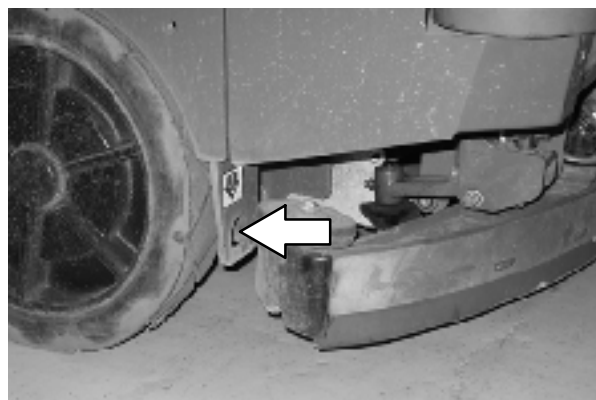

## MAINTENANCE

5. Position the machine as close to the front of the trailer or truck as possible.
6. Set the parking brake and place a block behind each wheel to prevent the machine from rolling.
7. Lower the scrub head.
8. Connect the tie-down straps to the holes in the right and left lower corners in front of the machine and the holes in the rear jacking brackets behind the rear tires.

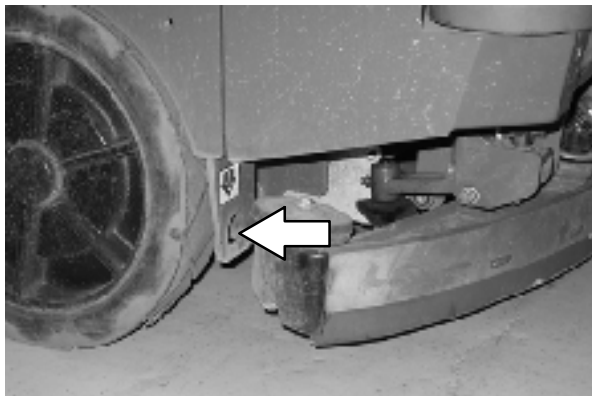
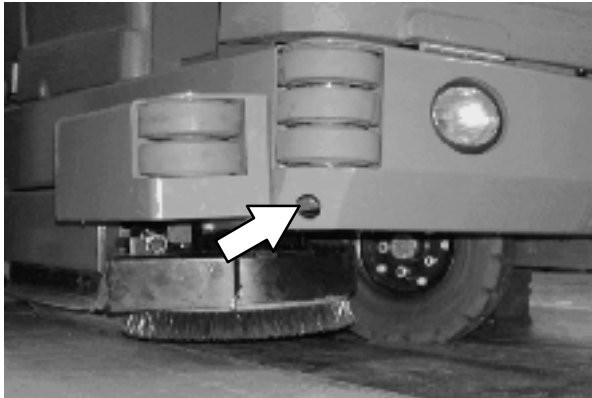

9. Route the tie-downs to the opposite ends of the machine and hook them to the brackets on the floor of the trailer or truck. Tighten the tie-down straps.

*NOTE: It may be necessary to install tie-down brackets to the floor of the trailer or truck.*

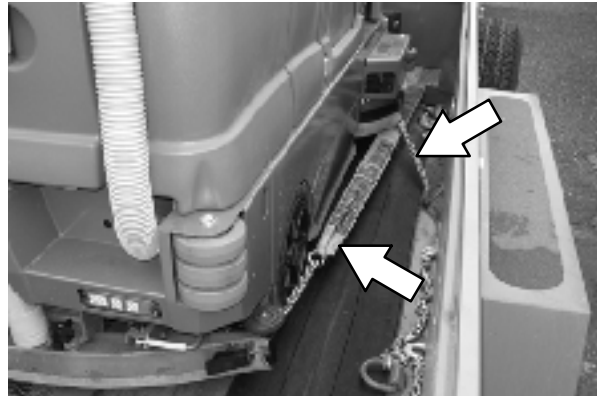

10. If the loading surface is not horizontal or is higher than 380 mm (15 in) from the ground, use a winch to unload machine.

If the loading surface is horizontal AND is 380 mm (15 in) or less from the ground, the machine may be driven off the truck or trailer.

**FOR SAFETY: When unloading machine off truck or trailer, use winch. Do not drive the machine off the truck or trailer unless the loading surface is horizontal AND 380 mm (15 in) or less from the ground.**

## MACHINE JACKING

Empty the debris tray, recovery tank, and solution tank before jacking up the machine. Jack up the machine at the designated locations. Use a hoist or jack capable of supporting the weight of the machine. Use jackstands to support the machine. Always stop the machine on a flat, level surface and block the tires before jacking up the machine.

Rear jacking locations are located directly behind the rear tires on each side of the machine.

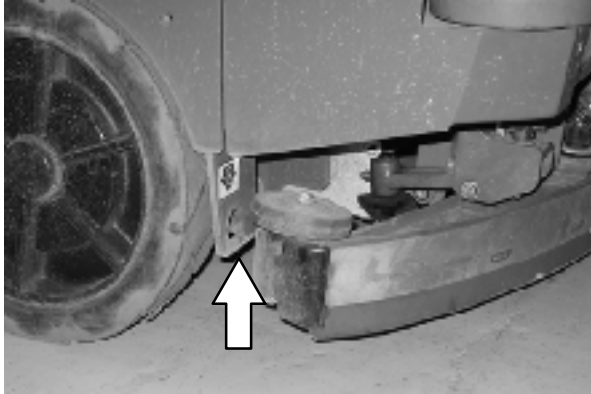

Front jacking locations are located on the frame directly in front of the front tire.

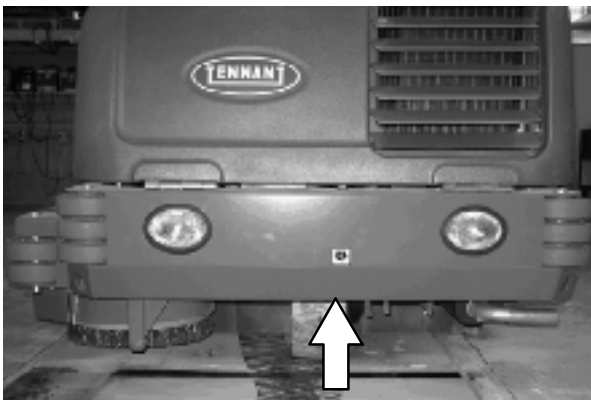

**FOR SAFETY: Before leaving or servicing machine, stop on level surface.**

**FOR SAFETY: When servicing machine, block machine tires before jacking machine up. Use a hoist or jack that will support the weight of the machine. Jack machine up at designated locations only. Support machine with jack stands.**

## STORAGE INFORMATION

The following steps should be taken prior to storing the machine for extended periods.

1. Drain and clean the solution and recovery tanks. Open the recovery tank and solution tank covers to allow the air to circulate.
2. Park the machine in a cool, dry area. Do not expose the machine to rain. Store indoors.
3. Remove the battery, or charge battery every three months.

## FREEZE PROTECTION

**FOR SAFETY: Before leaving or servicing machine, stop on level surface, set parking brake, and turn off machine.**

1. Be sure the solution tank and recovery tank are empty.
2. Pour 3.8 L (1 gal) of RV antifreeze into the solution tank.
3. Turn the key to the on position (**without starting the machine**).
4. Press the *1-STEP Scrub button*.
5. Repeatedly press the *Solution increase button (+)* until the solution flow is at the highest setting.
6. Press the *directional pedal* to circulate the RV Antifreeze solution completely through the system.
7. Press the *1-STEP Scrub button* again to turn off the system and turn the key to the off position.
8. If equipped with a spray nozzle, turn on pump until RV antifreeze solution sprays from the nozzle.
9. The remaining RV antifreeze solution does not need to be drained from the solution tank.

*NOTE: Storing or transporting machines equipped with the ES or the FaST system in freezing temperatures requires special procedures. Consult a TENNANT representative for more information.*

# SPECIFICATIONS

## SPECIFICATIONS

### GENERAL MACHINE DIMENSIONS/CAPACITIES

Item	Dimension/capacity
Length	2410 mm (95 in)
Height	1470 mm (58 in)
Height (with overhead guard)	2120 mm (83.5 in)
Width/frame (roller to roller)	1270 mm (50 in)
Width (rear squeegee)	1300 mm (51 in)
Width (with side brush)	1470 mm (58 in)
Cleaning path width (main brush length)-Cylindrical Brush	1020 mm (40 in)
Cleaning path width (with scrubbing side brush)-Cylindrical Brush	1370 mm (54 in)
Cleaning path width (with sweeping side brush)-Cylindrical Brush	1420 mm (56 in)
Main brush diameter (2)-Cylindrical Brush	300 mm (12 in)
Cleaning path width (main brush length)-Disk Brush	1070 mm (42 in)
Main brush diameter (3)-Disk Brush	360 mm (14 in)
Side brush diameter-scrubbing	410 mm (16 in)
Side brush diameter-sweeping (cylindrical only)	530 mm (21 in)
Solution tank capacity	303 L (80 gallons)
Recovery tank capacity	360 L (95 gallons)
Debris tray volume capacity	31 L (1.1 ft <sup>3</sup> )
Debris tray weight capacity	50 kg (110 lbs)
Weight - empty	1497 Kg (3300 lbs)
GVWR	2223 Kg (4900 lbs)
Transport ground clearance	80 mm (3 in)
Operating Sound Level At Operator Ear	81 ±1.5 dBA
Vibration level at steering wheel does not exceed	0.2 m/s <sup>2</sup>

### GENERAL MACHINE PERFORMANCE

Item	Measure
Minimum aisle turn	2790 mm (110 in)
Travel speed forward (maximum)	12.9 Km/h (8 mph)
Travel speed reverse (maximum)	4.8 Km/h (3 mph)
Maximum rated climb and descent at GVWR	10°/18%
Maximum rated climb and descent angle when scrubbing	8°/14%

### HYDRAULIC SYSTEM

System	Capacity	Fluid Type
Hydraulic reservoir	38 L (10 gal)	TENNANT part no. 65869 - above 7° C (45° F)
Hydraulic total	45 L (12 gal)	TENNANT part no. 65870 - below 7° C (45° F)

### STEERING

Type	Power source
Front wheel, hydraulic cylinder and rotary valve controlled	Hydraulic accessory pump

**POWER TYPE**

Engine	Type	Ignition	Cycle	Aspiration	Cylinders	Bore	Stroke
GM 1.6	Piston	Distributorless-type spark	4	Natural	4	79 mm (3.11 in)	81.5 mm (3.21 in)
	Displacement		Net power, governed			Net power, maximum	
	1600 cc (98 cu in)		23.2 kw (32 hp) @ 2400 rpm			39.5 kw (53 hp) @ 4000 rpm	
	Fuel		Cooling system			Electrical system	
	Gasoline, 87 octane minimum, unleaded Fuel tank: 42 L (11.2 gal)		Water/ethylene glycol antifreeze			12 V nominal	
	LPG, Fuel tank: 15 kg (33 lb)		Total: 7.5 L (2 gal) Radiator: 3.8 L (1 gal)			75 A alternator	
	Idle speed, no load		(Fast) governed speed, under load			Firing order	
	950 ± 50 rpm (machines serial number 001499 and below)  1350 ± 50 rpm (machines serial number 001500 and above)		2400 ± 50 rpm			1-3-4-2	
	Spark plug gap		Valve clearance, cold			Engine lubricating oil with filter	
	1 mm (0.035 in)		No Adjustment OHC Engine			3.5 L (3.7 qt) 5W30 SAE-SG/SH	

**BRAKING SYSTEM**

Type	Operation
Service brakes	Mechanical drum brakes (2), one per rear wheel, cable actuated
Parking brake	Utilize service brakes, cable actuated

**TIRES**

Location	Type	Size
Front (1)	Solid	140 mm x 460 mm (5.5 in x 18 in)
Rear (2)	Solid	90 mm x 410 mm (3.5 in x 16 in)

## SPECIFICATIONS

### FaST SYSTEM

Item	Measure
Solution pump (S/N 001743- )	12 Volt DC, 11A, 0.7 GPM & 1.4 GPM flow, (2 spees), 75 psi high-pressure shutdown
Solution pump (S/N 000000-001742)	12 Volt DC, 11A, 11.6 LPM (3.0 GPM) open flow, 45 psi bypass setting
Low solution flow rate	2.7 LPM (0.7 GPM)
High solution flow rate	5.4 LPM (1.4 GPM)
Low concentrate flow rate	2.6 CC/Minute (0.085 Liquid Ounces/Minute)
High concentrate flow rate	5.2 CC/Minute (0.17 Liquid Ounces/Minute)
Detergent pump (S/N 000000-001742)	12 Volt DC
Air pump (S/N 000000-001742)	12 Volt DC, 0.6 Maximum Amp draw
Air pump flow rate (S/N 000000-001742)	8.7 LPM (0.3 CFM) open flow

**MACHINE DIMENSIONS**

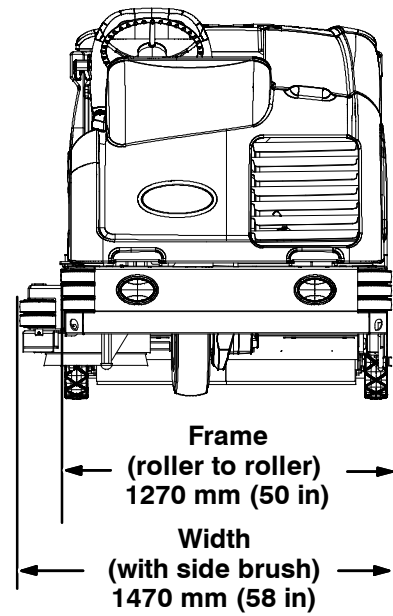
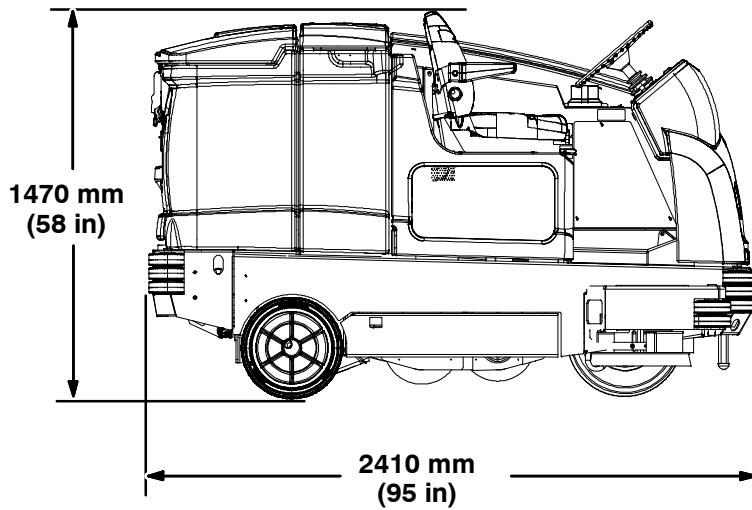
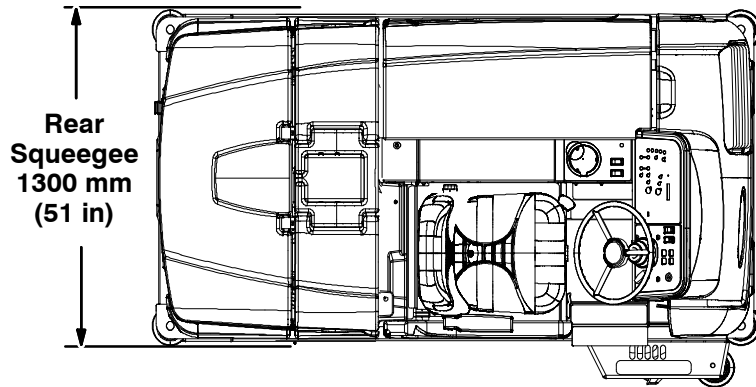





**Numbers**

1-STEP Scrub button, 12, 16, 23, 24, 25, 26, 27

**A**

Adjust operator seat, 14

Adjust steering column, 14

Adjusting the Cylindrical Brush Taper, 59

Adjusting the Cylindrical Brush Width, 59

Adjusting the Rear Squeegee Blade Deflection, 68

Adjusting the recovery tank drain plug, 32

Air Filter, 50

Alarms, 35

Fault Indicators, 35

**B**

Battery, 52

Brake pedal, 15

Brakes, 70

Brakes and Tires, 70

Brakes, 70

Front Wheel, 70

Parking Brake, 70

Tires, 70

Braking System, System specifications, 75

Brush and Pad Information, 16

Brush Information, 16

Buttons

1-STEP Scrub button, 25

Brush Pressure decrease button (-), 23

Brush Pressure increase button (+), 23

Engine Speed Button, 12

ES (Extended Scrub) button, 23

FaST button, 23

Scrub vacuum fan/squeegee button, 26

Side Brush button (Option), 12

Solution decrease button (-), 24

Solution increase button (+), 24

Supervisor Control Buttons, 13

Buttons, Controls, and Instruments, 9, 12

Bypass valve, 71

**C**

Capacities, 74

Changing the LPG Tank, 19

Charging System Indicator, 11

Check Engine Indicator, 11

Checking the Cylindrical Brush Pattern, 58

Checking the Disk Scrub Head Stop Bumpers, 56

Cleaning the FaST Supply Hose Connector, 62

Cleaning the FaST System Air Pump Filter, 62

Cleaning the FaST System Check Valves, 62

Cleaning the FaST System Filter Screen, 62

Conditions / Warnings, 36

Contents, 1

Controls and Instruments, 8, 9

Touch Panel, 9

Cooling System, 49

Cylindrical brushes, 56

Cylindrical Brush, Replacing or Rotating, 56

Cylindrical Brushes

Adjusting the Taper, 59

Adjusting the Width, 59

Checking the Main Brush Pattern, 58

Replacing or Rotating, 56

Cylindrical Brushes, Adjusting the Taper, 59

Cylindrical Brushes, Adjusting the Width, 59

Cylindrical Brushes, Checking the Pattern, 58

**D**

Dimensions, 74

Directional pedal, 15

Disk Brush, Replacing, 54

Disk brushes, 54-59

Disk Pads, Replace, 55

Disk Scrub Brushes, Replacing, 54

Disk Scrub Head Stop Bumpers, Checking, 56

Double Scrubbing, 26

Draining and Cleaning the Recovery Tank, 30

Draining the Recovery Tank with the Drain Hose, 30

Draining the Recovery Tank with the Drain Plug, 31

Draining and Cleaning the Solution Tank, 33

Draining the Recovery Tank with the Drain Hose, 30

Draining the Recovery Tank with the Drain Plug, 31

**E**

Electronic Pressure Regulator, 51  
Emptying and Cleaning the Debris Tray  
(Cylindrical scrub heads only), 28  
Engine, 49  
    Air Filter, 50  
    Cooling System, 49  
    Electronic Pressure Regulator, 51  
    Engine Belt, 52  
    Fuel Filter, 51  
    Spark Plugs, 52  
    Specifications, 75  
    Timing Belt, 52  
Engine Belt, 52  
Engine Harness Fuses and Relays, 54  
Engine Oil, 46  
Engine Oil Pressure Indicator, 11  
Engine Speed Button, 12

**F**

FaST System, 61  
    Cleaning the FaST Supply Hose Connector, 62  
    Cleaning the FaST System Air Pump Filter, 62  
    Cleaning the FaST System Check Valves, 62  
    Cleaning the FaST System Filter Screen, 62  
    Replacing the FaST-PAK Carton, 61  
Fault Indicators, 35  
Filling the Solution Tank, 21  
    Conventional Scrubbing Mode, 21  
    ES (Extended Scrub) Mode - Manually Filling  
    Tank, 22  
    ES (Extended Scrub) Mode with Auto-Fill, 22  
    Foam scrubbing (FaST Mode), 21  
Filters  
    Engine Air Filter, 50  
    Gasoline Fuel Filter, 51  
    Hydraulic Fluid Filter, 48  
    LPG Fuel Filter, 51  
Freeze Protection, 73  
Front Wheel Support Bearing, 46  
Front Wheel, Torque, 70  
Fuel Filter  
    Gasoline, 51  
    LPG, 51  
Fuel Indicator, 12  
Fuses and Relays, 53  
    Engine Harness Fuses and Relays, 54  
    Relay Panel Fuses and Relays, 53

**H**

Hazard Light Switch (Option), 13  
Headlights, 13  
Hour Meter, 13  
How the Machine Works, 16  
Hydraulic Fluid, 48  
Hydraulic Hoses, 49  
Hydraulic System, System specifications, 74  
Hydraulics, 48  
    Drain and refill hydraulic fluid reservoir, 48  
    Hydraulic Fluid, 48  
    Hydraulic Hoses, 49  
    Replace the filler cap, 48  
    Replace the hydraulic fluid filter, 48  
    Replace the hydraulic strainer outlet, 48

**I**

Incline, Rated, 17  
Indicators  
    Charging System Indicator, 11  
    Check Engine Indicator, 11  
    Conditions / Warnings, 36  
    Engine Oil Pressure Indicator, 11  
    Fault Indicators, 35  
    Fuel Indicator, 12  
    Hour Meter, 13

**L**

Leveling the Rear Squeegee, 67  
Lights  
    Hazard Light Switch (Option), 13  
    Headlights, 13  
    Operating, 13  
Lubrication, 46  
    Engine Oil, 46  
    Front Wheel Support Bearing, 46  
    Pivot Shaft (Disk Brushes), 47  
    Squeegee Caster Bearings, 46  
    Steering Cylinder Bearing, 46  
    Torque Tubes (Cylindrical Brushes), 47  
    Torque Tubes (Disk Brushes), 47

**M**

Machine components, 7  
 Machine Dimensions, 77  
 Machine Jacking, 73  
 Machine Operation, Pre–Operation Checklist, 18  
 Machine Performance  
   Aisle Turnaround Width, 74  
   Climb and Descent Angles, 74  
   Travel Speed (Maximum), 74  
 Machine Specifications, 74–77  
 Machine Troubleshooting, 41  
 Maintenance, 43–67  
   Cylindrical brushes, 56–61  
   Disk brushes, 54–59  
 Maintenance Chart, 44

**O**

Operating Lights, 13  
 Operation, 7–31  
 Operation of controls, 11  
 Operator seat, 14  
 Options, 37  
   Hazard Light, 13  
   Power Wand (Option), 39  
   Side Brush, 12  
   Spray Nozzle (Option), 37  
   Squeegee protectors, 15  
   Vacuum Wand (Option), 38

**P**

Pad Driver, Replacing, 54  
 Pad Information, 16  
 Parking brake pedal, 15  
 Pedals  
   Brake pedal, 15  
   Directional pedal, 15  
   Parking brake pedal, 15  
 Pivot Shaft (Disk Brushes), 47  
 Power Wand (Option), 39  
 Pre–Operation Checklist, 18  
 Propelling Motor, 70  
   Torque Shaft Nut, 70  
 Pushing or Towing the Machine, 71  
 Pushing, Towing, and Transporting the Machine,  
   71  
   Pushing or Towing the Machine, 71  
   Transporting the Machine, 71

**R**

Radiator, 50  
   Check hoses and clamps, 50  
   Clean core exterior, 50  
 Rated incline, 17  
 Rear Squeegee  
   Adjusting the Rear Squeegee Blade Deflection,  
     68  
   Leveling the Rear Squeegee, 67  
 Rear Squeegee Blade, Replacing (or Rotating)  
   the Rear Squeegee Blade, 63  
 Rear Squeegee, Replacing (or Rotating), 63  
 Recovery Tank Seal, 69  
 Relay Panel Fuses and Relays, 53  
 Replacing (or Rotating) the Rear Squeegee  
   Blades, 63  
 Replacing Cylindrical Scrub Brushes, 56  
 Replacing or Rotating Cylindrical Brushes, 56  
 Replacing or Rotating the Side Squeegee  
   Blades, 65  
 Replacing the FaST–PAK Carton, 61  
 Replacing the Side Brush (Option), 60  
 Replacing the Side Brush Squeegee Blade  
   (Option), 66  
 Rotating Cylindrical Scrub Brushes, 56

**S**

Safety  
   Labels, 5–7  
   Precautions, 3–5  
 Scrub brushes, Cylindrical brushes, 56  
 Scrub Brushes and Pads, 54  
   Disk brushes, 54  
   Replacing Disk Brushes or Pad Driver, 54  
   Replacing Scrub Pads, 55  
 Scrub Head Skirt, 69  
 Scrub Pads, Replace, 55  
 Scrubbing, 25  
 Seals, 69  
   Recovery Tank Seal, 69  
   Solution Tank Seals, 69  
 Seat belts, 14  
 Seat, Operator, 14  
 Setting Brush Pressure, 23  
 Setting Conventional Solution Flow, 24  
 Setting ES (Extended Scrub) Mode, 23  
 Setting ES Solution Flow, 24

Setting FaST Mode, 23  
Setting FaST Solution Flow, 24  
Setting Scrub Modes, 23  
    Setting Brush Pressure, 23  
    Setting ES (Extended Scrub) Mode, 23  
    Setting ES Solution Flow, 24  
    Setting FaST Mode, 23  
    Setting Solution Flow, 24  
        Conventional and FaST Mode, 24  
        ES (Extended Scrub) Mode, 24  
Setting the Engine Speed, 12  
Side Brush, 12  
Side Brush (Option), 60  
    Replacing the Side Brush, 60  
    Replacing the Side Brush Squeegee, 66  
Side Brush Squeegee (Option), Replacing, 66  
Side Brush, Replacing, 60  
Side Squeegee Blades, 65  
    Replacing or Rotating the Side Squeegee  
    Blades, 65  
Side Squeegee Blades, Replacing or Rotating,  
65  
Skirts and Seals, 69  
    Recovery Tank Seal, 69  
    Scrub Head Skirt, 69  
    Solution Tank Seals, 69  
Solution Tank Seals, 69  
Spark Plugs, 52  
Specifications, 74–77  
    Braking system, 75  
    FaST System, 76  
    Hydraulic System, 74  
    Machine Capacities, 74  
    Machine Dimensions, 74  
    Machine Performance, 74  
    Power Type, 75  
    Steering, 74  
    Tires, 75  
Spray Nozzle (Option), 37  
Squeegee Blades, 63  
    Adjusting the Rear Squeegee Blade Deflection,  
    68  
    Leveling the Rear Squeegee, 67  
    Replacing (or Rotating) the Rear Squeegee  
    Blades, 63  
    Replacing or Rotating the Side Squeegee  
    Blades, 65  
    Replacing the Side Brush Squeegee Blade  
    (Option), 66  
Squeegee Caster Bearings, 46  
Squeegee Protectors (Option), 15  
Starting the Machine, 20

Steering, Specifications, 74  
Steering column tilt knob, 14  
Steering Cylinder Bearing, 46  
Storage Information, 73  
    Freeze Protection, 73  
    Storing the Machine, 73  
Supervisor Control Buttons, 13  
Symbol definitions, 10–12

**T**

Timing Belt, 52  
Tires, 70  
    Specifications, 75  
Torque Shaft Nut, Propelling Motor, 70  
Torque Tubes (Cylindrical Brushes), 47  
Torque Tubes (Disk Brushes), 47  
Touch Panel, 9  
Towing the Machine, 71  
Transporting the Machine, 71  
Turning Off the Machine, 20

**V**

Vacuum Wand (Option), 38

**W**

Warning Indicators, 11, 35  
    Charging System Indicator, 11  
    Check Engine Indicator, 11  
    Conditions / Warnings, 36  
    Engine Oil Pressure Indicator, 11  
    Fault Indicators, 35  
Water Pickup Mode (No Scrubbing), 27  
Wheels, 70  
While Operating the Machine, 17